

## Application & Main Feature

Commercial Grade ( High Temperature Application )

## Series

C2012 [EIA CC0805]

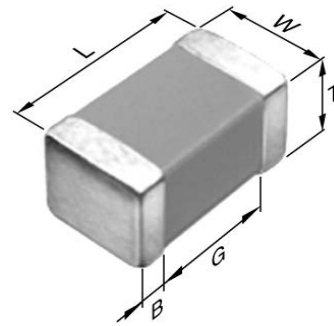

## Dimensions

L	2.00mm +/-0.2mm
W	1.25mm +/-0.2mm
T	1.25 +/-0.2mm
B	0.2mm Min.
G	0.5mm Min.

## Temperature Characteristic

NP0 (-55 to 150 degC 0+/-30ppm/degC)

## Rated Voltage

2E (250Vdc)

## Capacitance

4.7nF

## Capacitance Tolerance

J (+/-5%)

## Q Factor

1000 Min.

## Insulation Resistance

10Gohm Min

## AEC-Q200

Not Applicable

