

Features

- High speed switching
- Tight parameter distribution
- Safe paralleling
- Low thermal resistance
- 6 μ s short-circuit withstand time
- Lead free package

Applications

- Photovoltaic inverters
- Uninterruptible power supply
- Welding
- Power factor correction
- High switching frequency converters

Description

Using advanced proprietary trench gate and field stop structure, this IGBT leads to an optimized compromise between conduction and switching losses maximizing the efficiency for high switching frequency converters. Furthermore, a slightly positive $V_{CE(sat)}$ temperature coefficient and a very tight parameter distribution result in an easier paralleling operation.

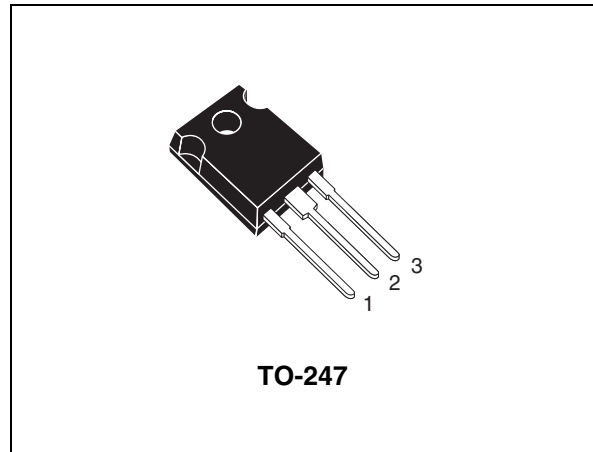

Figure 1. Internal schematic diagram

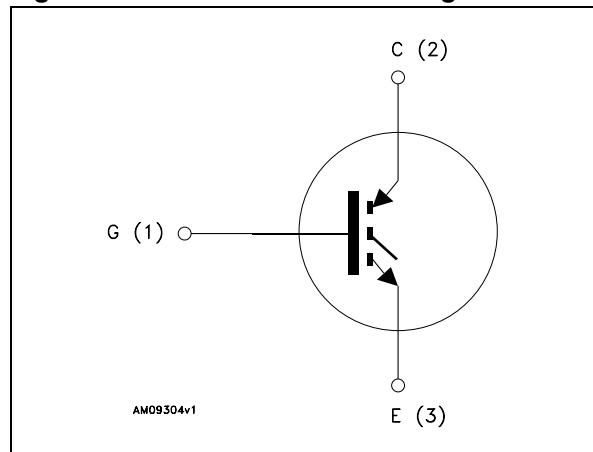

Table 1. Device summary

| Order code | Marking | Package | Packaging |
|------------|----------|---------|-----------|
| STGW60H65F | GW60H65F | TO-247 | Tube |

1 Electrical ratings

Table 2. Absolute maximum ratings

| Symbol | Parameter | Value | Unit |
|----------------|---|-------------|--------------------|
| V_{CES} | Collector-emitter voltage ($V_{GE} = 0$) | 650 | V |
| I_C | Continuous collector current at $T_C = 25\text{ °C}$ | 120 | A |
| I_C | Continuous collector current at $T_C = 100\text{ °C}$ | 60 | A |
| $I_{CP}^{(1)}$ | Pulsed collector current | 240 | A |
| V_{GE} | Gate-emitter voltage | ± 20 | V |
| P_{TOT} | Total dissipation at $T_C = 25\text{ °C}$ | 360 | W |
| t_{SC} | Short-circuit withstand time at $V_{CC} = 400\text{ V}$, $V_{GE} = 15\text{ V}$ | 6 | μs |
| T_{STG} | Storage temperature range | - 55 to 150 | $^{\circ}\text{C}$ |
| T_J | Operating junction temperature | | |

1. Pulse width limited by maximum junction temperature and turn-off within RBSOA

Table 3. Thermal data

| Symbol | Parameter | Value | Unit |
|------------|-------------------------------------|-------|-----------------------------|
| R_{thJC} | Thermal resistance junction-case | 0.35 | $^{\circ}\text{C}/\text{W}$ |
| R_{thJA} | Thermal resistance junction-ambient | 50 | $^{\circ}\text{C}/\text{W}$ |

2 Electrical characteristics

$T_J = 25\text{ °C}$ unless otherwise specified.

Table 4. Static

| Symbol | Parameter | Test conditions | Min. | Typ. | Max. | Unit |
|---------------|--|--|------|------|------|---------------|
| $V_{(BR)CES}$ | Collector-emitter breakdown voltage ($V_{GE} = 0$) | $I_C = 2\text{ mA}$ | 650 | | | V |
| $V_{CE(sat)}$ | Collector-emitter saturation voltage | $V_{GE} = 15\text{ V}, I_C = 60\text{ A}$ | | 1.9 | | V |
| | | $V_{GE} = 15\text{ V}, I_C = 60\text{ A}$ $T_J = 125\text{ °C}$ | | 2.1 | | |
| $V_{GE(th)}$ | Gate threshold voltage | $V_{CE} = V_{GE}, I_C = 1\text{ mA}$ | | 6.0 | | V |
| I_{CES} | Collector cut-off current ($V_{GE} = 0$) | $V_{CE} = 650\text{ V}$ | | | 25 | μA |
| I_{GES} | Gate-emitter leakage current ($V_{CE} = 0$) | $V_{GE} = \pm 20\text{ V}$ | | | 250 | nA |

Table 5. Dynamic

| Symbol | Parameter | Test conditions | Min. | Typ. | Max. | Unit |
|-----------|------------------------------|---|------|------|------|------|
| C_{ies} | Input capacitance | $V_{CE} = 25\text{ V}, f = 1\text{ MHz}, V_{GE}=0$ | | 7150 | | pF |
| C_{oes} | Output capacitance | | - | 275 | - | pF |
| C_{res} | Reverse transfer capacitance | | | | 140 | |
| Q_g | Total gate charge | $V_{CC} = 400\text{ V}, I_C = 60\text{ A},$ $V_{GE} = 15\text{ V}$ | | 217 | | nC |
| Q_{ge} | Gate-emitter charge | | | 67 | | nC |
| Q_{gc} | Gate-collector charge | | | 97 | | nC |

Table 6. Switching on/off (inductive load)

| Symbol | Parameter | Test conditions | Min. | Typ. | Max. | Unit |
|----------------------|-----------------------|--|------|------|------|------|
| $t_{d(on)}^{(1)}$ | Turn-on delay time | $V_{CE} = 400\text{ V}, I_C = 60\text{ A},$ $R_G = 10\ \Omega, V_{GE} = 15\text{ V}$ | | 65 | | ns |
| $t_r^{(1)}$ | Current rise time | | - | 30 | - | ns |
| $(di/dt)_{on}^{(1)}$ | Turn-on current slope | | | | 2000 | |
| $t_{d(on)}^{(1)}$ | Turn-on delay time | $V_{CE} = 400\text{ V}, I_C = 60\text{ A},$ $R_G = 10\ \Omega, V_{GE} = 15\text{ V}$ $T_J = 125\text{ °C}$ | | 63 | | ns |
| $t_r^{(1)}$ | Current rise time | | - | 33 | - | ns |
| $(di/dt)_{on}^{(1)}$ | Turn-on current slope | | | | 1800 | |

Table 6. Switching on/off (inductive load)

| | | | | | | |
|----------------|-----------------------|--|---|-----|---|----|
| $t_r(V_{off})$ | Off voltage rise time | $V_{CE} = 400\text{ V}, I_C = 60\text{ A},$ $R_G = 10\ \Omega, V_{GE} = 15\text{ V}$ | - | 35 | - | ns |
| $t_{d(off)}$ | Turn-off delay time | | | 180 | | ns |
| t_f | Current fall time | | | 43 | | ns |
| $t_r(V_{off})$ | Off voltage rise time | $V_{CE} = 400\text{ V}, I_C = 60\text{ A},$ $R_G = 10\ \Omega, V_{GE} = 15\text{ V}$ $T_J = 125\text{ }^\circ\text{C}$ | - | 46 | - | ns |
| $t_{d(off)}$ | Turn-off delay time | | | 210 | | ns |
| t_f | Current fall time | | | 85 | | ns |

1. E_{on} is the turn-on losses when a SiC diode (STPSC1206D) is used in the test circuit in [Figure 17](#). If the IGBT is offered in a package with a co-pack diode, the co-pack diode is used as external diode. IGBTs and diode are at the same temperature (25 °C and 125 °C).

Table 7. Switching energy (inductive load)

| Symbol | Parameter | Test conditions | Min. | Typ. | Max. | Unit |
|-----------------|---------------------------|--|------|------|------|------|
| $E_{on}^{(1)}$ | Turn-on switching losses | $V_{CE} = 400\text{ V}, I_C = 60\text{ A},$ $R_G = 10\ \Omega, V_{GE} = 15\text{ V}$ | - | 0.75 | - | mJ |
| $E_{off}^{(2)}$ | Turn-off switching losses | | | 1.05 | | mJ |
| E_{ts} | Total switching losses | | | 1.80 | | mJ |
| $E_{on}^{(1)}$ | Turn-on switching losses | $V_{CE} = 400\text{ V}, I_C = 60\text{ A},$ $R_G = 10\ \Omega, V_{GE} = 15\text{ V}$ $T_J = 125\text{ }^\circ\text{C}$ | - | 0.8 | - | mJ |
| $E_{off}^{(2)}$ | Turn-off switching losses | | | 1.4 | | mJ |
| E_{ts} | Total switching losses | | | 2.2 | | mJ |

1. E_{on} is the turn-on losses when a SiC diode (STPSC1206D) is used in the test circuit in [Figure 17](#). If the IGBT is offered in a package with a co-pack diode, the co-pack diode is used as external diode. IGBTs and diode are at the same temperature (25 °C and 125 °C).
2. Turn-off losses include also the tail of the collector current.

2.1 Electrical characteristics (curves)

Figure 2. Output characteristics ($T_J = -40\text{ }^\circ\text{C}$) Figure 3. Output characteristics ($T_J = 25\text{ }^\circ\text{C}$)

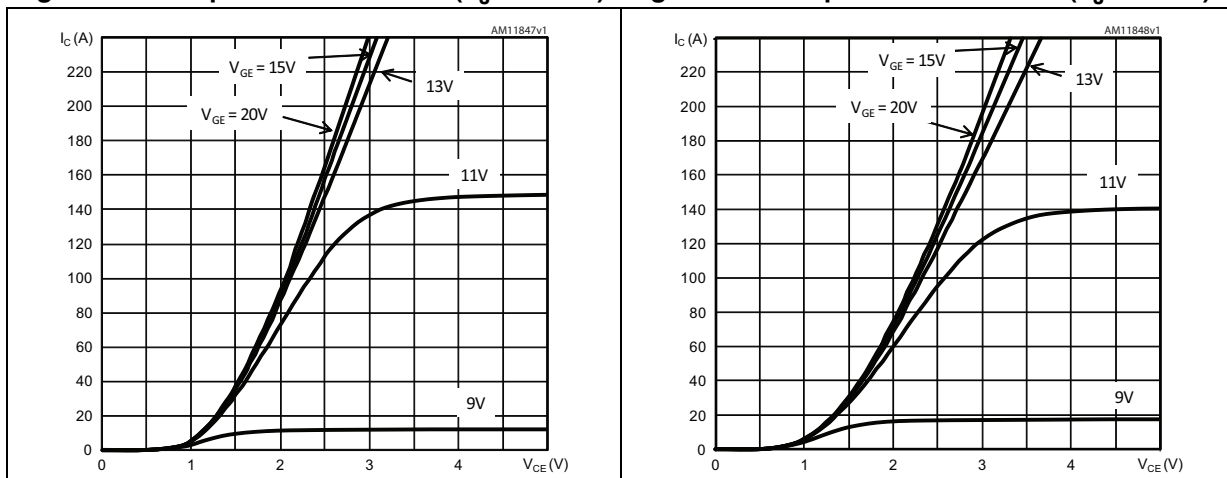

Figure 4. Output characteristics ($T_J = 150\text{ }^\circ\text{C}$) Figure 5. Transfer characteristics

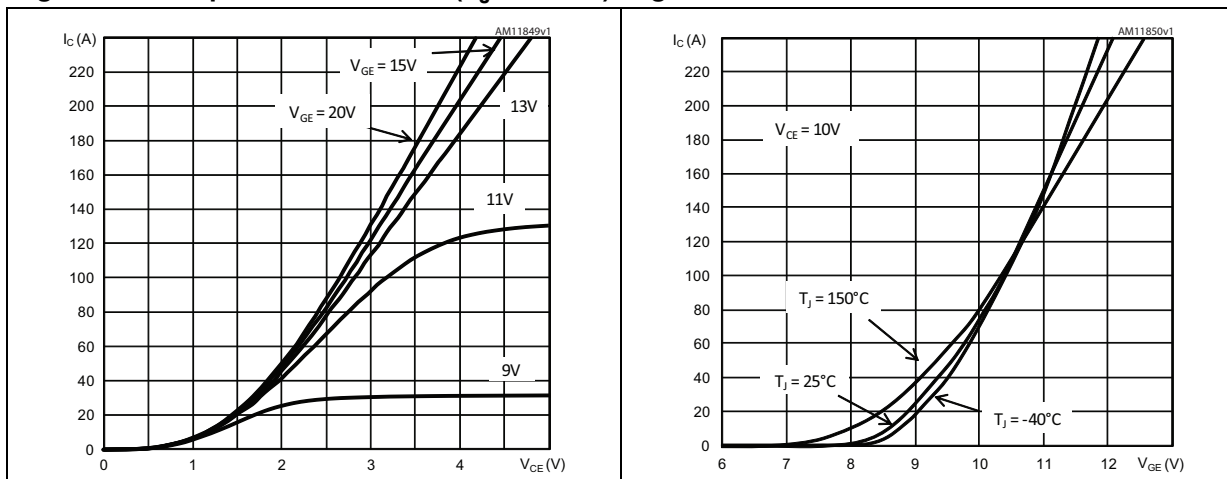

Figure 6. $V_{CE(SAT)}$ vs. junction temperature Figure 7. $V_{CE(SAT)}$ vs. collector current

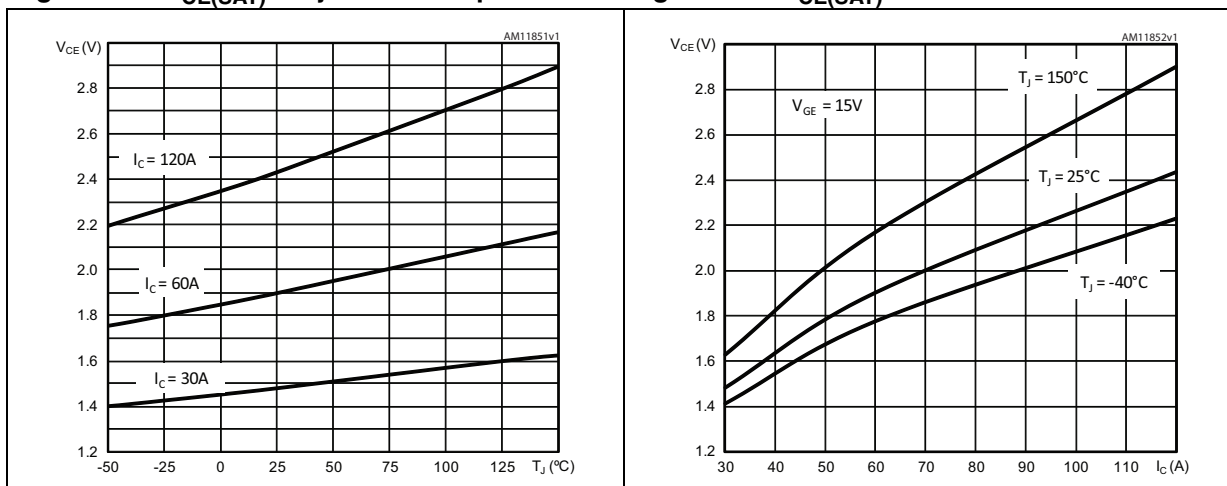

Figure 8. Normalized $V_{GE(th)}$ vs. junction temperature

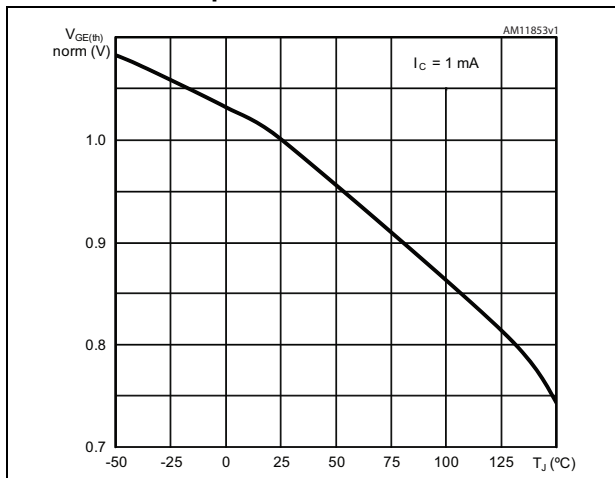

Figure 9. Gate charge vs. gate-emitter voltage

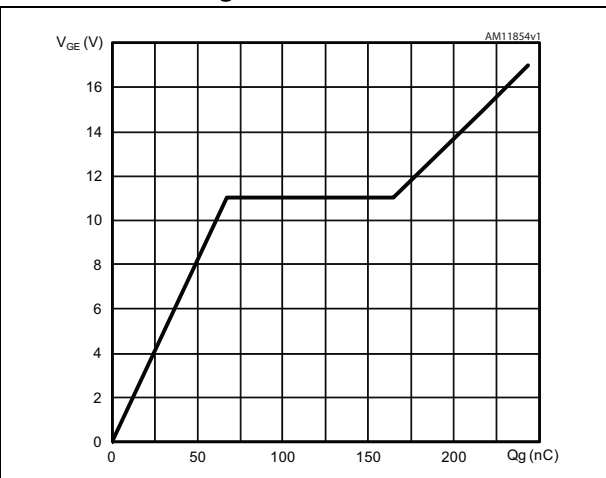

Figure 10. Capacitance variations ($f = 1$ MHz, $V_{GE} = 0$)

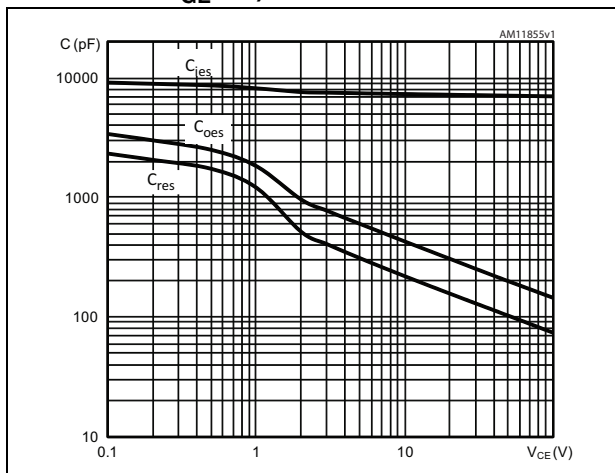

Figure 11. Switching losses vs. collector current

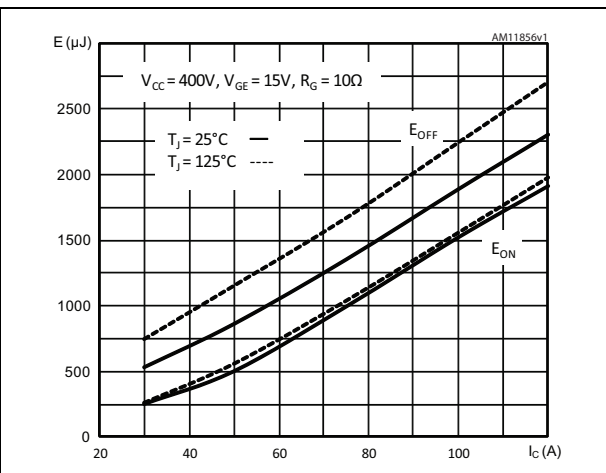

Figure 12. Switching losses vs. gate resistance

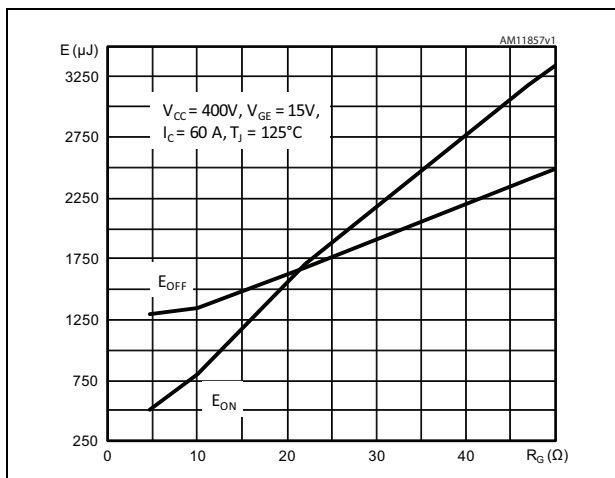

Figure 13. Switching losses vs. temperature

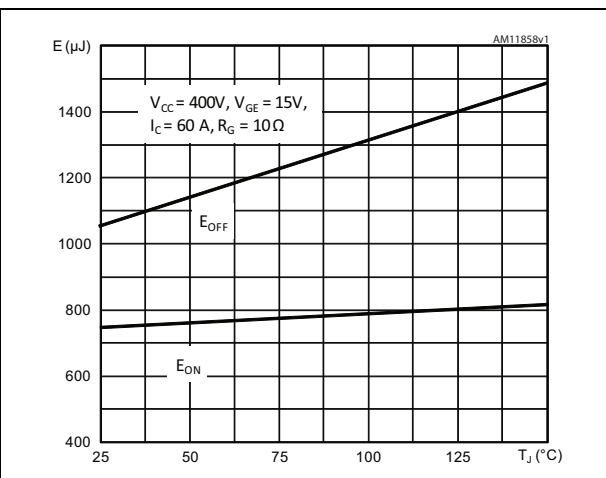

Figure 14. Turn-OFF SOA

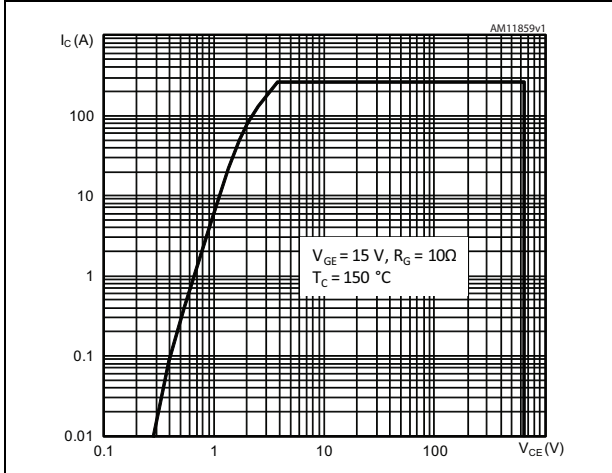

Figure 15. Short circuit time & current vs. V_{GE}

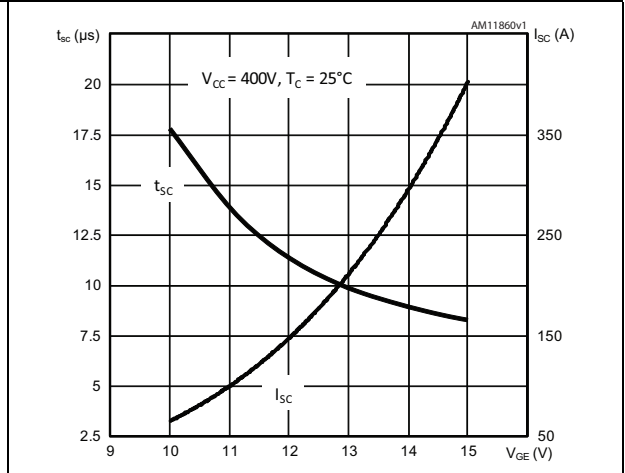
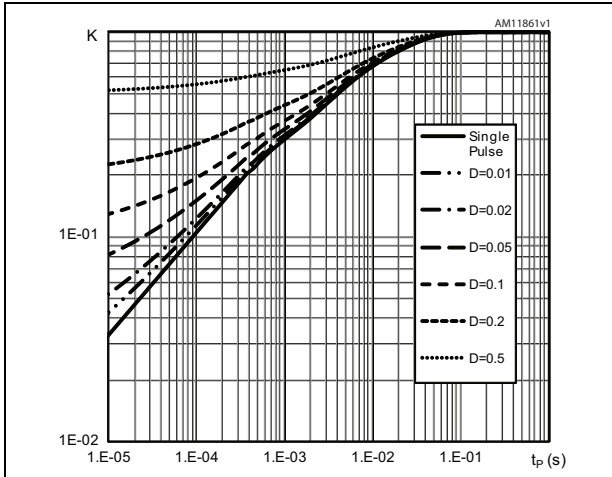

Figure 16. Maximum normalized Z_{th} junction to case (IGBT)



4 Package mechanical data

In order to meet environmental requirements, ST offers these devices in different grades of ECOPACK® packages, depending on their level of environmental compliance. ECOPACK® specifications, grade definitions and product status are available at: www.st.com. ECOPACK® is an ST trademark.

Table 8. TO-247 mechanical data

| Dim. | mm | | |
|------|-------|-------|-------|
| | Min. | Typ. | Max. |
| A | 4.85 | | 5.15 |
| A1 | 2.20 | | 2.60 |
| b | 1.0 | | 1.40 |
| b1 | 2.0 | | 2.40 |
| b2 | 3.0 | | 3.40 |
| c | 0.40 | | 0.80 |
| D | 19.85 | | 20.15 |
| E | 15.45 | | 15.75 |
| e | | 5.45 | |
| L | 14.20 | | 14.80 |
| L1 | 3.70 | | 4.30 |
| L2 | | 18.50 | |
| ØP | 3.55 | | 3.65 |
| ØR | 4.50 | | 5.50 |
| S | | 5.50 | |

Figure 20. TO-247 drawing

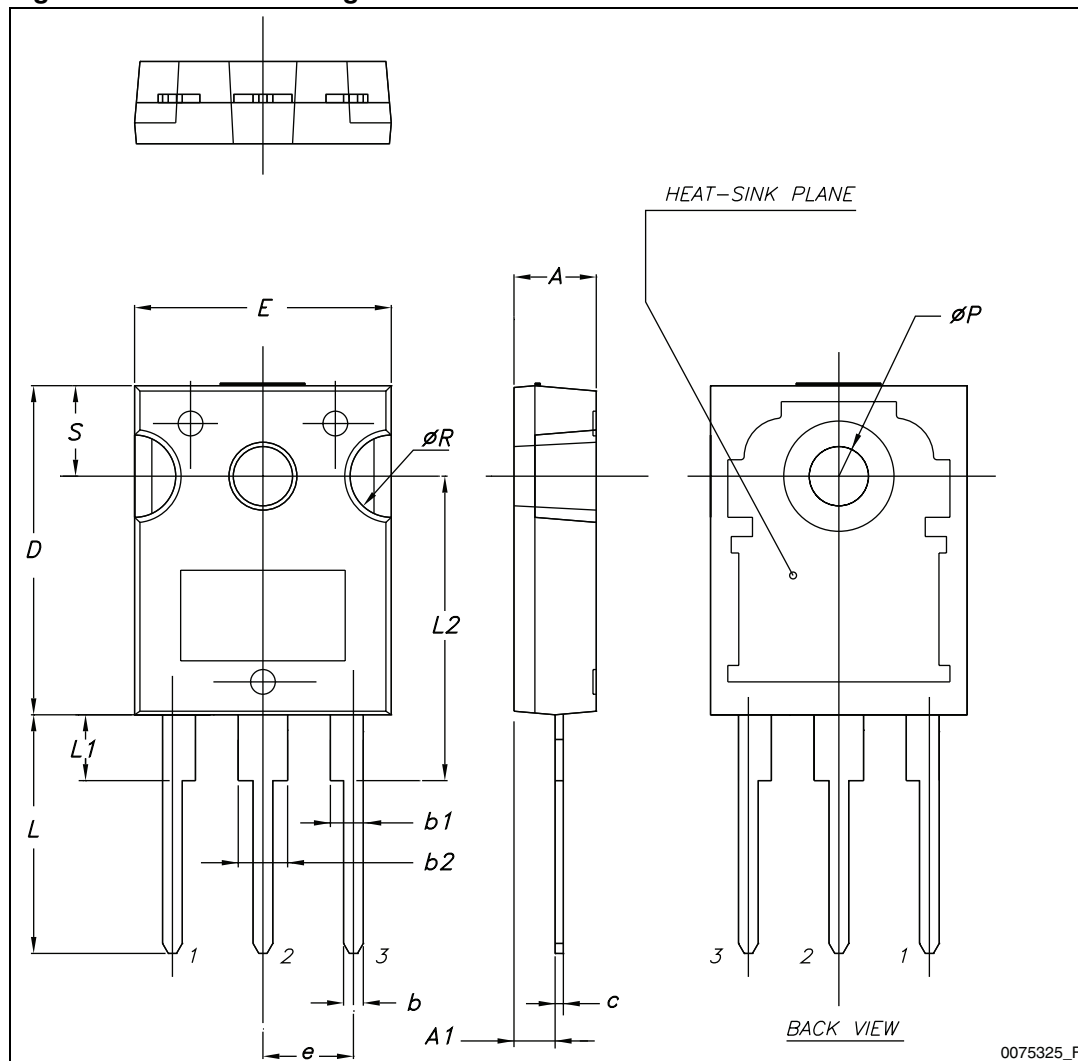

0075325_F

5 Revision history

Table 9. Document revision history

| Date | Revision | Changes |
|-------------|----------|---|
| 05-Jul-2011 | 1 | Initial release. |
| 12-Jan-2012 | 2 | Document status promoted from preliminary data to datasheet. |
| 10-Feb-2012 | 3 | Added: Section 2.1: Electrical characteristics (curves) . |
| 31-Jul-2012 | 4 | Updated: Figure 8 on page 6 . |

Please Read Carefully:

Information in this document is provided solely in connection with ST products. STMicroelectronics NV and its subsidiaries ("ST") reserve the right to make changes, corrections, modifications or improvements, to this document, and the products and services described herein at any time, without notice.

All ST products are sold pursuant to ST's terms and conditions of sale.

Purchasers are solely responsible for the choice, selection and use of the ST products and services described herein, and ST assumes no liability whatsoever relating to the choice, selection or use of the ST products and services described herein.

No license, express or implied, by estoppel or otherwise, to any intellectual property rights is granted under this document. If any part of this document refers to any third party products or services it shall not be deemed a license grant by ST for the use of such third party products or services, or any intellectual property contained therein or considered as a warranty covering the use in any manner whatsoever of such third party products or services or any intellectual property contained therein.

UNLESS OTHERWISE SET FORTH IN ST'S TERMS AND CONDITIONS OF SALE ST DISCLAIMS ANY EXPRESS OR IMPLIED WARRANTY WITH RESPECT TO THE USE AND/OR SALE OF ST PRODUCTS INCLUDING WITHOUT LIMITATION IMPLIED WARRANTIES OF MERCHANTABILITY, FITNESS FOR A PARTICULAR PURPOSE (AND THEIR EQUIVALENTS UNDER THE LAWS OF ANY JURISDICTION), OR INFRINGEMENT OF ANY PATENT, COPYRIGHT OR OTHER INTELLECTUAL PROPERTY RIGHT.

UNLESS EXPRESSLY APPROVED IN WRITING BY TWO AUTHORIZED ST REPRESENTATIVES, ST PRODUCTS ARE NOT RECOMMENDED, AUTHORIZED OR WARRANTED FOR USE IN MILITARY, AIR CRAFT, SPACE, LIFE SAVING, OR LIFE SUSTAINING APPLICATIONS, NOR IN PRODUCTS OR SYSTEMS WHERE FAILURE OR MALFUNCTION MAY RESULT IN PERSONAL INJURY, DEATH, OR SEVERE PROPERTY OR ENVIRONMENTAL DAMAGE. ST PRODUCTS WHICH ARE NOT SPECIFIED AS "AUTOMOTIVE GRADE" MAY ONLY BE USED IN AUTOMOTIVE APPLICATIONS AT USER'S OWN RISK.

Resale of ST products with provisions different from the statements and/or technical features set forth in this document shall immediately void any warranty granted by ST for the ST product or service described herein and shall not create or extend in any manner whatsoever, any liability of ST.

ST and the ST logo are trademarks or registered trademarks of ST in various countries.

Information in this document supersedes and replaces all information previously supplied.

The ST logo is a registered trademark of STMicroelectronics. All other names are the property of their respective owners.

© 2012 STMicroelectronics - All rights reserved

STMicroelectronics group of companies

Australia - Belgium - Brazil - Canada - China - Czech Republic - Finland - France - Germany - Hong Kong - India - Israel - Italy - Japan - Malaysia - Malta - Morocco - Philippines - Singapore - Spain - Sweden - Switzerland - United Kingdom - United States of America

www.st.com