

PROTECTION PRODUCTS - RailClamp®

Description

RClamp®3522T provides ESD protection for USB3.0 and other high-speed ports. It may be used to meet the ESD immunity requirements of IEC 61000-4-2. RClamp3522T is designed to minimize both the ESD peak clamping and the TLP clamping. The dynamic resistance is minimized (0.47 Ohms typical) for optimum protection of sensitive circuits. Maximum capacitance is only 0.40pF. This allows the RClamp3522T to be used in applications operating in excess of 6GHz without appreciable signal attenuation. These devices are manufactured using Semtech's proprietary low voltage technology for superior electrical characteristics. RClamp3522T is in a 3-pin SGP1006N3T package. It measures 1.0 x 0.6 mm with a nominal height of only 0.4mm. Leads are finished with lead-free NiPdAu. Each device will protect two lines operating up to 3.5 volts. The combination of low peak ESD clamping, low dynamic resistance, and low capacitance makes this device suitable for applications such as USB 3.0, audio and V-By-One interfaces in portable devices.

Features

- ◆ Transient protection for data lines to **IEC 61000-4-2 (ESD) ±15kV (air), ±12kV (contact) IEC 61000-4-4 (EFT) 40A (tp = 5/50ns) Cable Discharge Event (CDE)**
- ◆ Ultra-small package (1.0 x 0.6 x 0.5mm)
- ◆ Protects up to two data lines
- ◆ Low capacitance: **0.40pF**
- ◆ Dynamic Resistance: 0.47 Ohms Typical
- ◆ Low ESD clamping voltage
- ◆ Operating voltage: 3.5V
- ◆ Solid-state silicon-avalanche technology

Mechanical Characteristics

- ◆ SGP1006N3T package
- ◆ Pb-Free, Halogen Free, RoHS/WEEE Compliant
- ◆ Nominal Dimensions: 1.0 x 0.6 x 0.40 mm
- ◆ Lead Finish: NiPdAu
- ◆ Molding compound flammability rating: UL 94V-0
- ◆ Marking : Marking code + dot matrix date code
- ◆ Packaging : Tape and Reel

Applications

- ◆ USB 2.0 / USB 3.0
- ◆ V-By-One
- ◆ Display Port
- ◆ MHL / MDDI
- ◆ LVDS Interfaces
- ◆ eSATA Interfaces

Dimensions

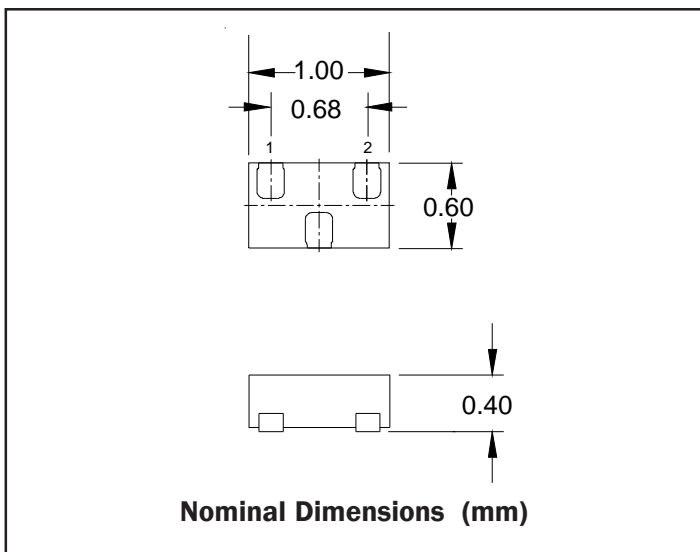

Schematic & Pin Configuration

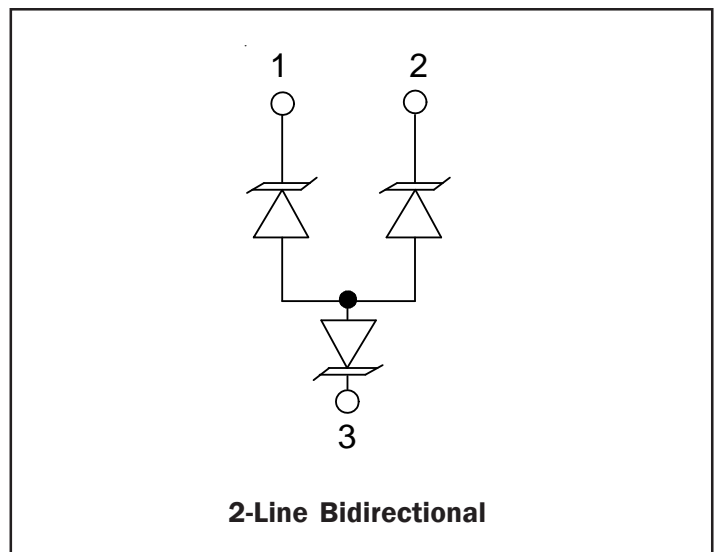

PROTECTION PRODUCTS
Absolute Maximum Rating

Rating	Symbol	Value	Units
Peak Pulse Power ($t_p = 8/20\mu s$)	P_{pk}	50	Watts
Maximum Peak Pulse Current ($t_p = 8/20\mu s$)	I_{pp}	4	Amps
ESD per IEC 61000-4-2 (Air) ¹ ESD per IEC 61000-4-2 (Contact) ¹	V_{ESD}	+/- 15 +/- 12	kV
Operating Temperature	T_J	-40 to +125	°C
Storage Temperature	T_{STG}	-55 to +150	°C

Electrical Characteristics (T=25°C)

Parameter	Symbol	Conditions	Minimum	Typical	Maximum	Units
Reverse Stand-Off Voltage	V_{RWM}				3.5	V
Breakdown Voltage	V_{BR}	$I_{BR} = 1mA$	4.5	6.7	8.5	V
Reverse Leakage Current	I_R	$V_{RWM} = 3.5V$		0.01	0.05	μA
Reverse Leakage Current	I_R	$V_{RWM} = 2V$		<0.001	0.025	μA
Clamping Voltage	V_C	$I_{PP} = 1A, t_p = 8/20\mu s$		9.5	10	V
Clamping Voltage	V_C	$I_{PP} = 4A, t_p = 8/20\mu s$		10.5	13	V
ESD Clamping Voltage ²	V_C	$I_{PP} = 4A,$ $t_{lp} = 0.2/100ns$		8.8		V
ESD Clamping Voltage ²	V_C	$I_{PP} = 16A,$ $t_{lp} = 0.2/100ns$		14.5		V
Trigger Voltage ²	V_{TRIG}	$t_{lp} = 0.2/100ns$		8		V
Dynamic Resistance ^{2, 3}	R_{DYN}	$t_{lp} = 0.2 / 100ns$		0.47		Ohms
Junction Capacitance	C_j	$V_R = 0V, f = 1MHz$		0.33	0.40	pF

Notes

- 1) ESD gun return path connected to ESD ground reference plane.
- 2) Transmission Line Pulse Test (TLP) Settings: $t_p = 100ns$, $t_r = 0.2ns$, I_{TLP} and V_{TLP} averaging window: $t_1 = 70ns$ to $t_2 = 90ns$.
- 3) Dynamic resistance calculated from $I_{pp} = 4A$ to $I_{pp} = 16A$
- 4) Device is electrically symmetrical

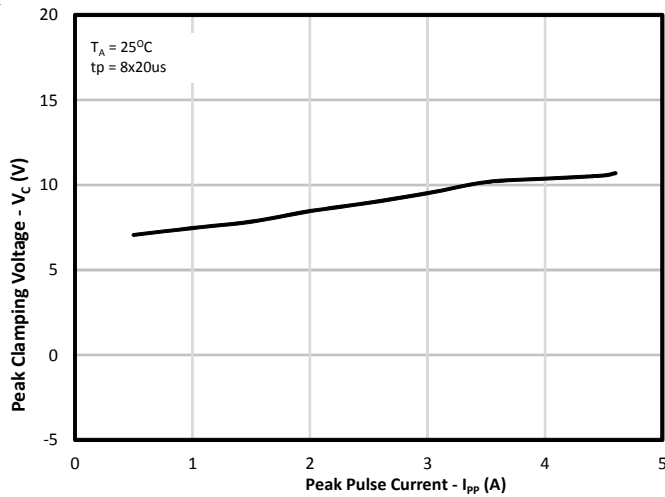
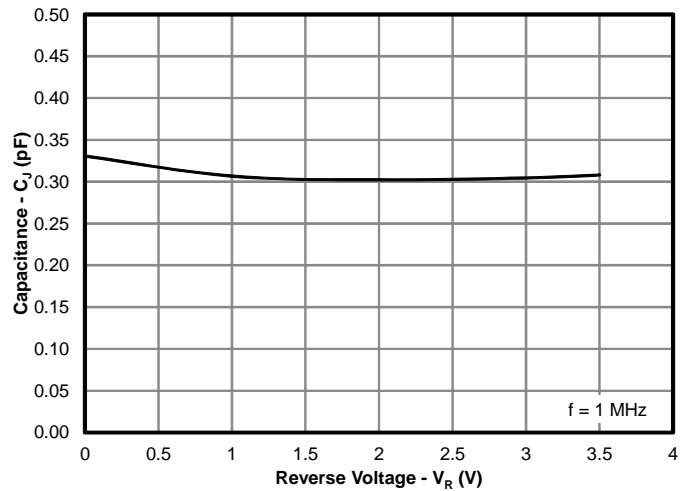
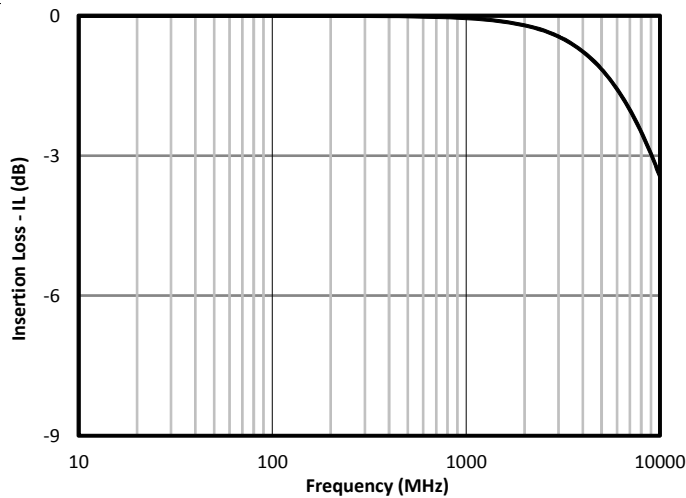
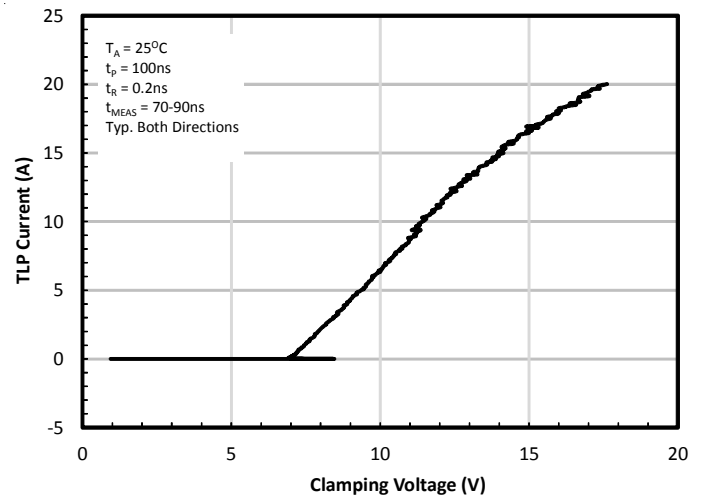
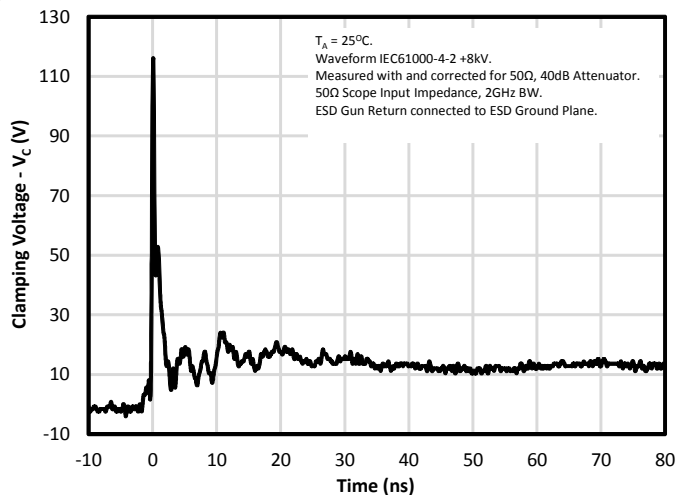
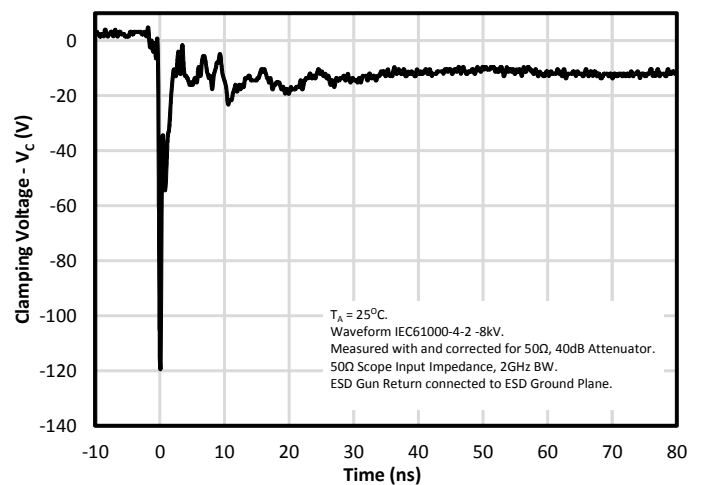
PROTECTION PRODUCTS
Typical Characteristics
Clamping Voltage vs. Peak Pulse Current

Capacitance vs. Reverse Voltage

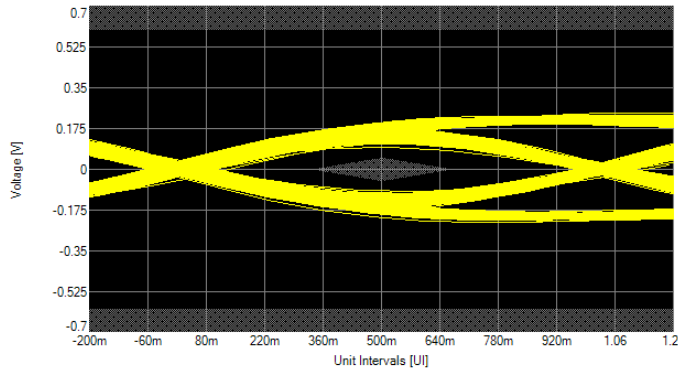
Typical Insertion Loss (S21)

TLP Characteristic

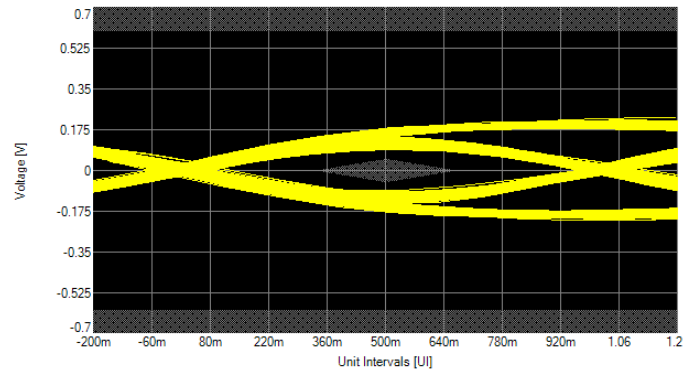
ESD Clamping (+8kV Contact per IEC 61000-4-2)

ESD Clamping (-8kV Contact per IEC 61000-4-2)

USB3.0 Eye Pattern without RClamp3522T



USB3.0 Eye Pattern with RClamp3522T



PROTECTION PRODUCTS
Applications Information
Device Connection Options

RClamp3522T is designed to protect two data lines operating up to 3.5 volts. The device is bidirectional and may be used on lines where the signal polarity is above and below ground. The diagram at the right shows an example pin configuration with pin 3 connected to ground. However, due to the device symmetry, any pin may be connected to ground with the remaining pins connected to the protected lines.

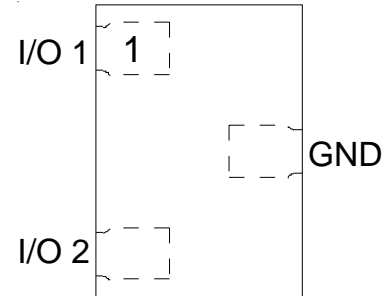
Example Pin Configuration

Assembly Guidelines

The small size of this device means that some care must be taken during the mounting process to insure reliable solder joint. The table below provides Semtech's recommended assembly guidelines for mounting this device. The figure at the right details Semtech's recommended aperture based on the below recommendations. Note that these are only recommendations and should serve only as a starting point for design since there are many factors that affect the assembly process. Exact manufacturing parameters will require some experimentation to get the desired solder application.

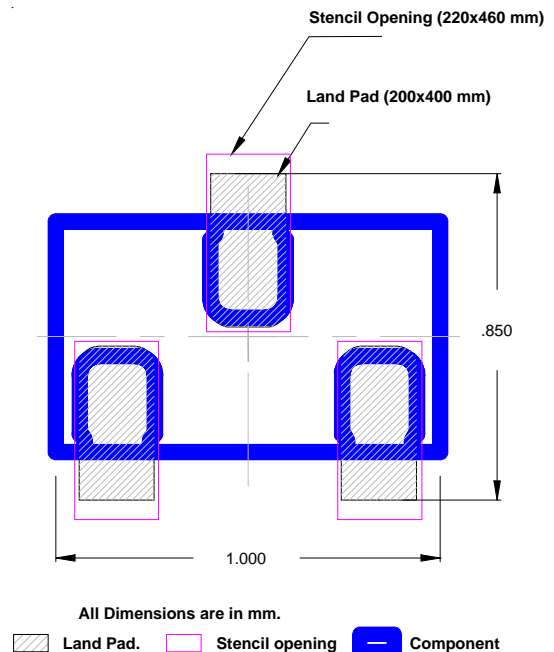
Assembly Parameter	Recommendation
Solder Stencil Design	Laser cut, Electro-polished
Aperture shape	Rectangular
Solder Stencil Thickness	0.100 mm (0.004")
Solder Paste Type	Type 4 size sphere or smaller
Solder Reflow Profile	Per JEDEC J-STD-020
PCB Solder Pad Design	Non-Solder mask defined
PCB Pad Finish	OSP OR NiAu

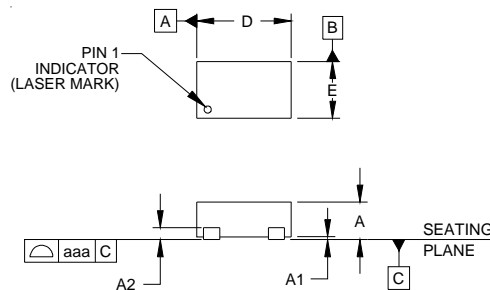
Recommended Mounting Pattern

PROTECTION PRODUCTS
Outline Drawing - SGP1006N3T

DIM	MILLIMETERS		
	MIN	NOM	MAX
A	0.37	0.40	0.43
A1	0.00	0.02	0.05
A2	(0.13)		
b	0.145	0.17	0.195
b1	0.175	0.20	0.225
D	0.90	1.00	1.10
E	0.50	0.60	0.70
e	0.68 BSC		
L	0.225	0.25	0.275
N	3		
aaa	0.08		
bbb	0.10		

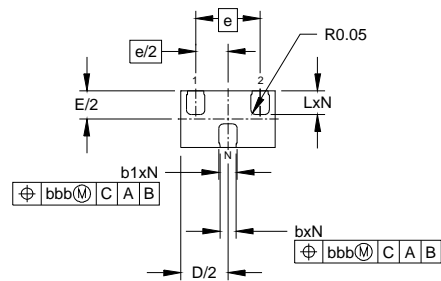
NOTES:

1. CONTROLLING DIMENSIONS ARE IN MILLIMETERS (ANGLES IN DEGREES).

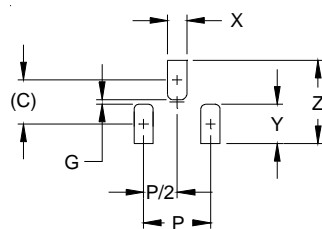
Land Pattern - SGP1006N3T

DIMENSIONS	
DIM	MILLIMETERS
C	(0.45)
G	0.05
P	0.68
X	0.20
Y	0.40
Z	0.85

NOTES:

1. CONTROLLING DIMENSIONS ARE IN MILLIMETERS (ANGLES IN DEGREES).
2. THIS LAND PATTERN IS FOR REFERENCE PURPOSES ONLY. CONSULT YOUR MANUFACTURING GROUP TO ENSURE YOUR COMPANY'S MANUFACTURING GUIDELINES ARE MET.

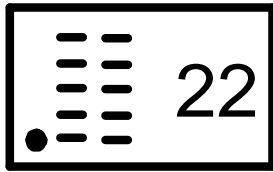
PROTECTION PRODUCTS
Marking Codes

Ordering Information

Part Number	Qty per Reel	Tape Type	Reel Size
RClamp3522T.TFT	15,000	Paper	7 Inch

Notes:

RailClamp and RClamp are trademarks of Semtech Corporation

Notes:

- 1) Device is electrically symmetrical
- 2) Marking will also include line matrix date code

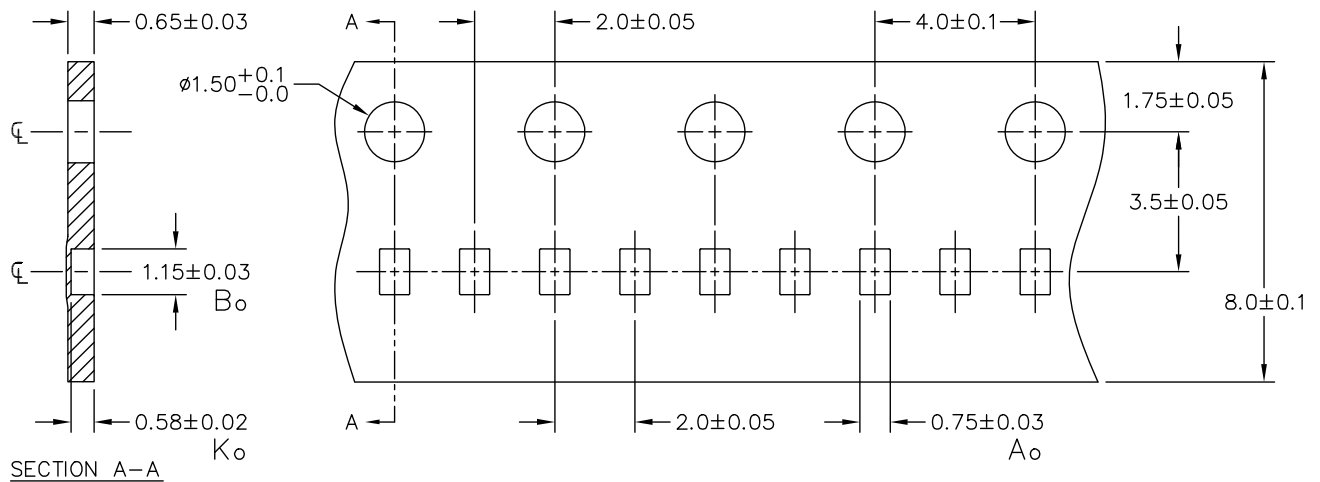
Carrier Tape Specification

NOTES: ALL DIMENSIONS IN MILLIMETERS UNLESS OTHERWISE SPECIFIED.

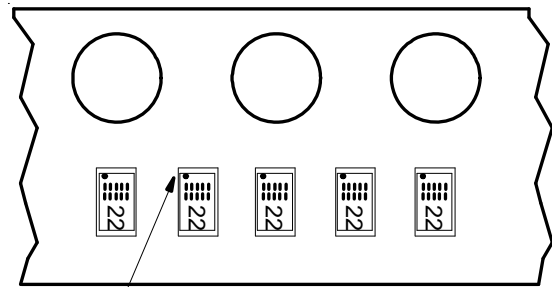

Pin 1 Location
(Towards Sprocket Holes)

Device Orientation in Tape

Contact Information

Semtech Corporation
Protection Products Division
200 Flynn Road, Camarillo, CA 93012
Phone: (805)498-2111 FAX (805)498-3804