

# C0603CH1E3R3C030BA

TDK Item Description : C0603CH1E3R3CT\*\*\*\*



## Application & Main Feature

Commercial Grade ( General (Up to 50V) )

## Series

C0603 [EIA CC0201]

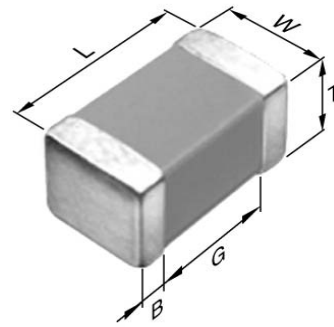

## Dimensions

L 0.60mm +/-0.03mm  
 W 0.30mm +/-0.03mm  
 T 0.30mm +/-0.03mm  
 B 0.10mm Min.  
 G 0.20mm Min.

## Temperature Characteristic

CH (-25 to 85 degC 0+/-60ppm/degC)

## Rated Voltage

1E (25Vdc)

## Capacitance

3.3pF

## Capacitance Tolerance

C (+/-0.25pF)

## Q Factor

466 Min.

## Insulation Resistance

10Gohm Min.

## AEC-Q200

Not Applicable

**|Z|, ESR vs. Freq. Characteristics**

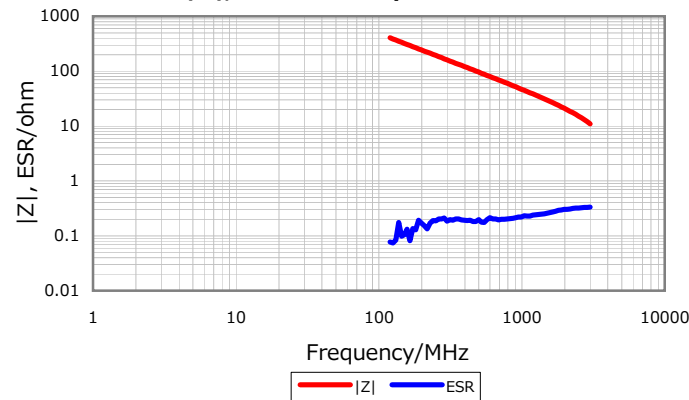

**DC Bias Characteristic**

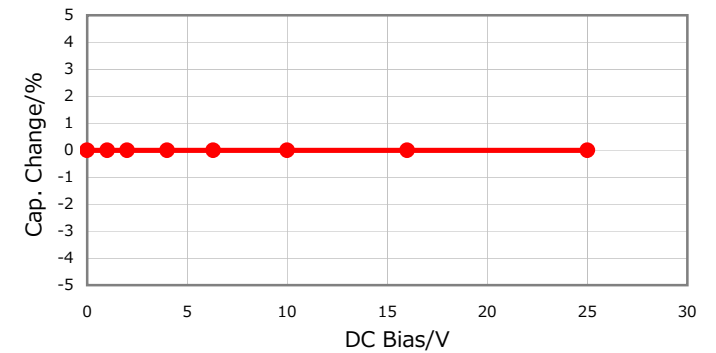

**Cap. vs. Freq. Characteristic**

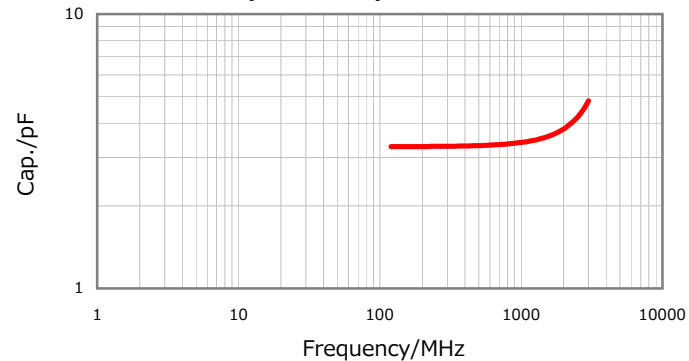

**Temperature Characteristics**

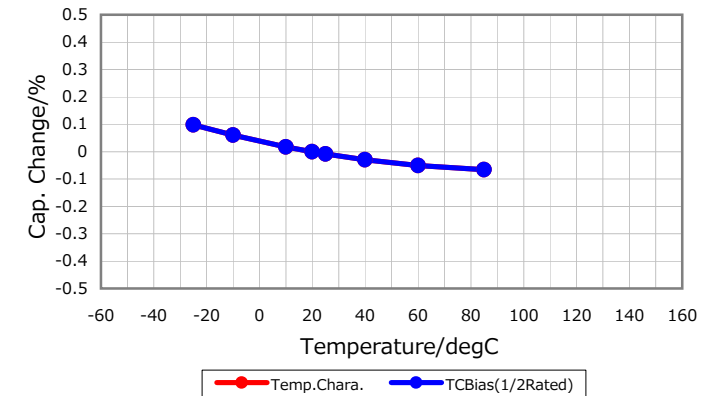

Characterization Sheet ( Multilayer Ceramic Chip Capacitors )



All specifications are subject to change without notice.

January 2, 2016