

PROTECTION PRODUCTS - MicroClamp[®]

Description

μ Clamp[®] TVS diodes are designed to protect sensitive electronics from damage or latch-up due to ESD. They are designed to replace multilayer varistors (MLVs) in portable applications such as cell phones, notebook computers, and other portable electronics. They feature large cross-sectional area junctions for conducting high transient currents. This device offers desirable characteristics for board level protection including fast response time, low operating and clamping voltage, and no device degradation.

The μ Clamp[®]0552T is in a 3-pin SLP1006N3T package. It measures 1.0 x 0.6 mm with a nominal height of only 0.4mm. The leads are finished with lead-free NiPdAu. Each device will protect two lines operating at 5 volts. It gives the designer the flexibility to replace multiple single line devices in space constrained applications. They may be used to meet the ESD immunity requirements of IEC 61000-4-2. The combination of small size and high ESD surge capability makes them ideal for use in portable applications such as cellular phones, digital cameras, and MP3 players.

Features

- ◆ High ESD withstand Voltage: +/-**17kV** (Contact) per **IEC 61000-4-2**
- ◆ Very small PCB area: 0.6mm²
- ◆ Protects up to two data lines
- ◆ Low reverse current: <5nA typical (VR=5V)
- ◆ Working voltage: +/- 5V
- ◆ Low capacitance: <9pF (VR=0V)
- ◆ Low dynamic resistance: 0.55 Ohms (Typ)
- ◆ Solid-state silicon-avalanche technology

Mechanical Characteristics

- ◆ SLP1006N3T package
- ◆ Pb-Free, Halogen Free, RoHS/WEEE Compliant
- ◆ Nominal Dimensions: 1.0 x 0.6 x 0.40 mm
- ◆ Lead Finish: NiPdAu
- ◆ Molding compound flammability rating: UL 94V-0
- ◆ Marking : Marking code + dot matrix date code
- ◆ Packaging : Tape and Reel

Applications

- ◆ Cellular Handsets & Accessories
- ◆ Keypads, Side Keys
- ◆ Audio Ports
- ◆ LCD Connectors
- ◆ Digital Lines

Dimensions

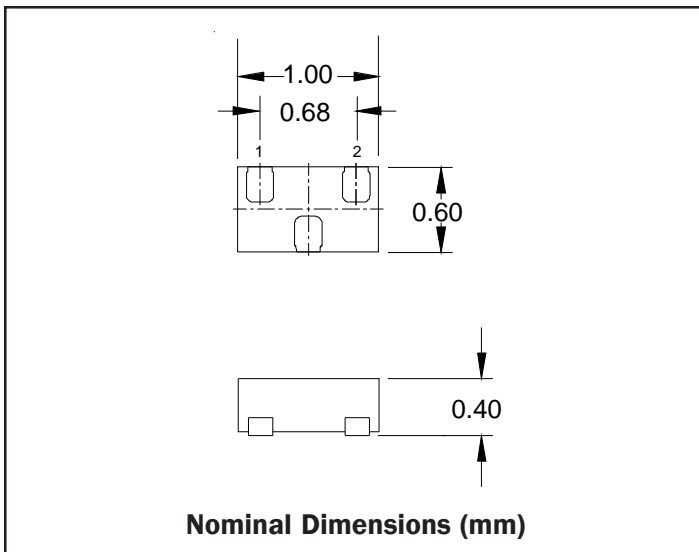

Schematic & PIN Configuration

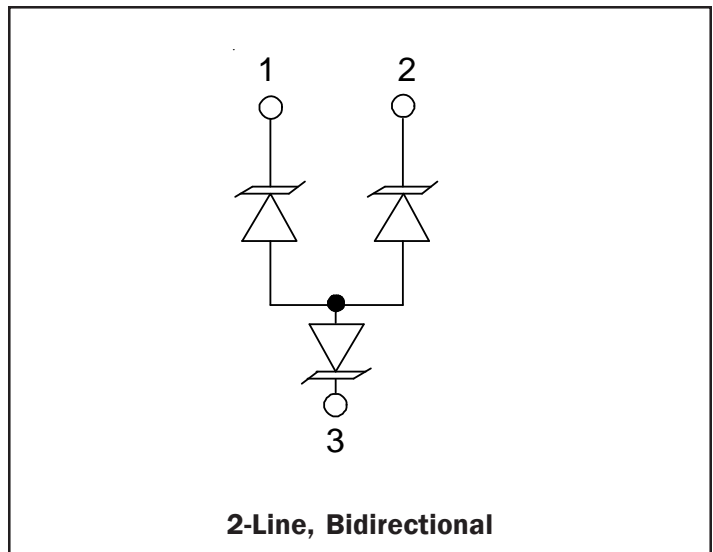

PROTECTION PRODUCTS
Absolute Maximum Rating

Rating	Symbol	Value	Units
Peak Pulse Power (tp = 8/20μs)	P_{pk}	30	Watts
Maximum Peak Pulse Current (tp = 8/20μs)	I_{pp}	2	Amps
ESD per IEC 61000-4-2 (Air) ESD per IEC 61000-4-2 (Contact)	V_{ESD}	+/- 19 +/- 17	kV
Operating Temperature	T_J	-55 to +125	°C
Storage Temperature	T_{STG}	-55 to +150	°C

Electrical Characteristics (T=25°C)

Parameter	Symbol	Conditions	Minimum	Typical	Maximum	Units
Reverse Stand-Off Voltage	V_{RWM}	Any I/O Pin to GND			5	V
Reverse Breakdown Voltage	V_{BR}	$I_t = 1mA$ Any I/O Pin to GND	6	8.2	9.5	V
Reverse Leakage Current	I_R	$V_{RWM} = 5V, T=25°C$ Any I/O Pin to GND		3	50	nA
Clamping Voltage	V_C	$I_{pp} = 2A, tp = 8/20μs$ Any I/O Pin to GND			15	V
ESD Clamping Voltage	V_C	$I_{pp} = 16A,$ $t_{lp} = 0.2/100ns$		17		V
Dynamic Resistance	R_{dyn}	tp = 100ns		0.55		Ohms
Junction Capacitance	C_j	$V_R = 0V, f = 1MHz$ Any I/O Pin to GND		7	9	pF

PROTECTION PRODUCTS

Typical Characteristics

Non-Repetitive Peak Pulse Power vs. Pulse Time



Clamping Voltage vs. Peak Pulse Current ($t_p=8/20\mu$ s)

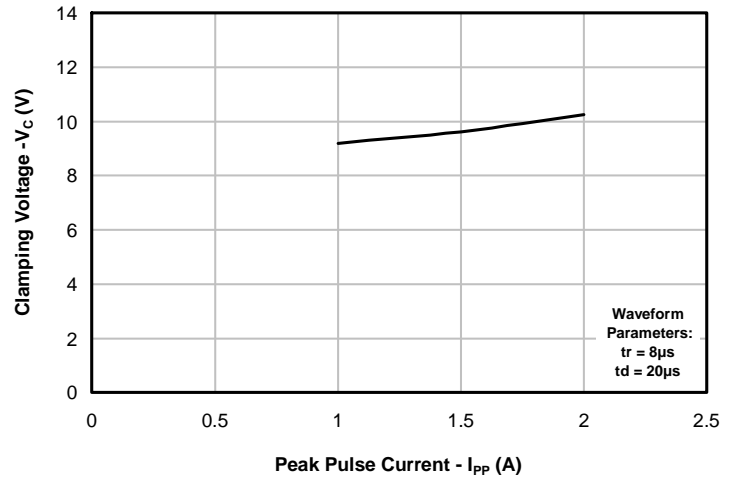

Junction Capacitance vs. Reverse Voltage

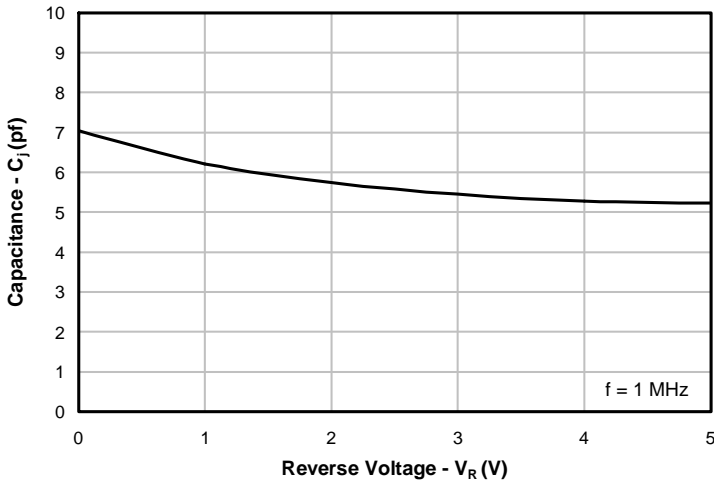

TLP Characteristic

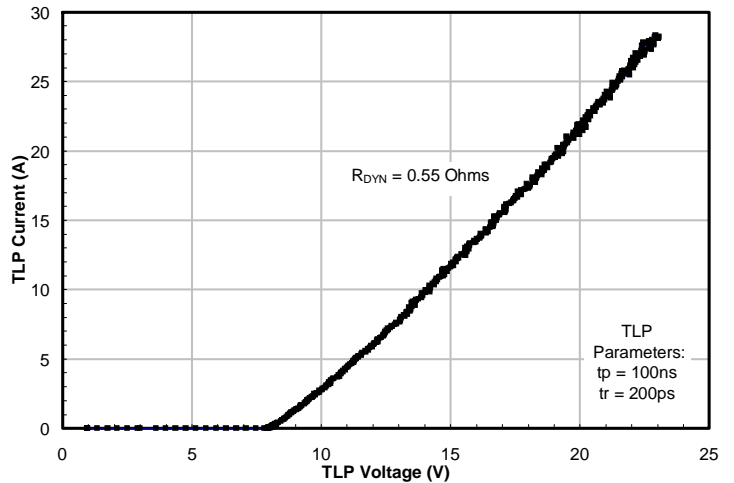

ESD Clamping (+8kV Contact per IEC 61000-4-2)

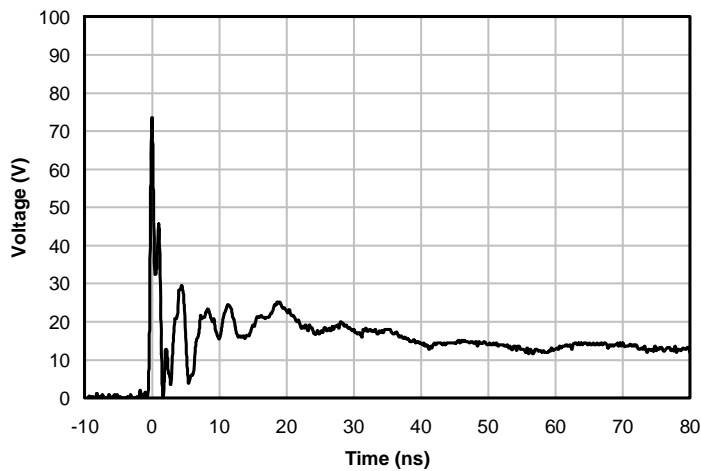

ESD Clamping (-8kV Contact per IEC 61000-4-2)

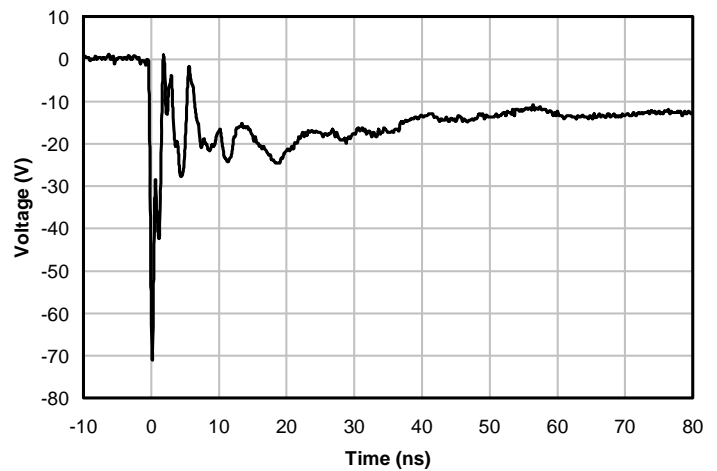

PROTECTION PRODUCTS

Typical Characteristics

Typical Insertion Loss S21

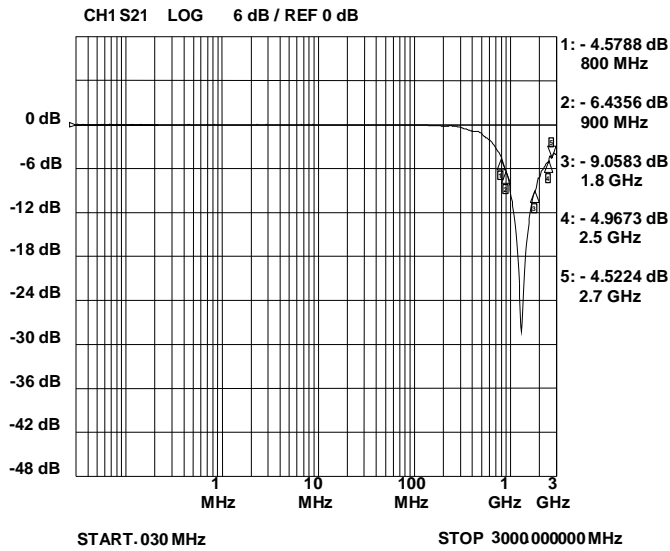

Analog Crosstalk

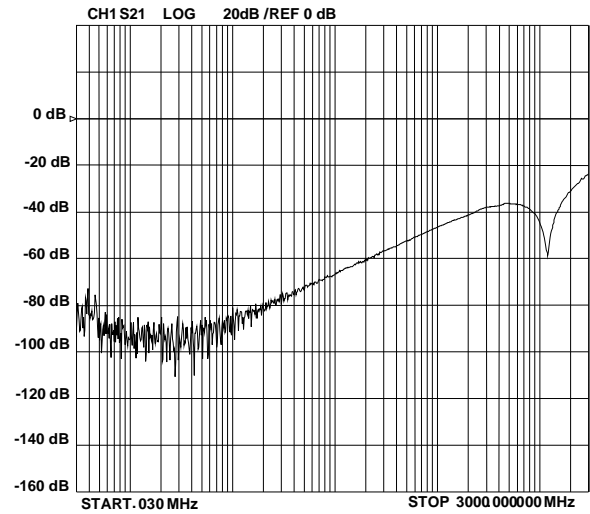

Reverse Leakage Current (IR) vs. Temperature

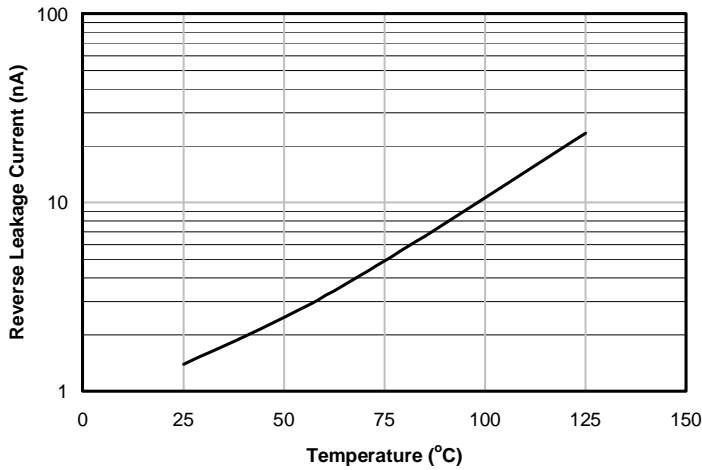

PROTECTION PRODUCTS

Applications Information

Device Connection Options

The μ Clamp0552T is designed to protect two data lines operating up to 5 volts. The device is bidirectional and may be used on lines where the signal polarity is above and below ground. The diagram at the right shows an example pin configuration with pin 3 connected to ground. However, due to the device symmetry, any pin may be connected to ground with the remaining pins connected to the protected lines.

Example Pin Configuration

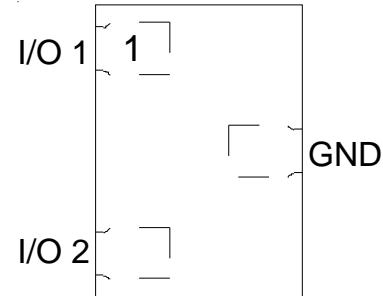

Assembly Guidelines

The small size of this device means that some care must be taken during the mounting process to insure reliable solder joint. The table below provides Semtech's recommended assembly guidelines for mounting this device. The figure at the right details Semtech's recommended aperture based on the below recommendations. Note that these are only recommendations and should serve only as a starting point for design since there are many factors that affect the assembly process. The exact manufacturing parameters will require some experimentation to get the desired solder application.

Assembly Parameter	Recommendation
Solder Stencil Design	Laser cut, Electro-polished
Aperture shape	Rectangular
Solder Stencil Thickness	0.100 mm (0.004")
Solder Paste Type	Type 4 size sphere or smaller
Solder Reflow Profile	Per JEDEC J-STD-020
PCB Solder Pad Design	Non-Solder mask defined
PCB Pad Finish	OSP OR NiAu

Recommended Mounting Pattern

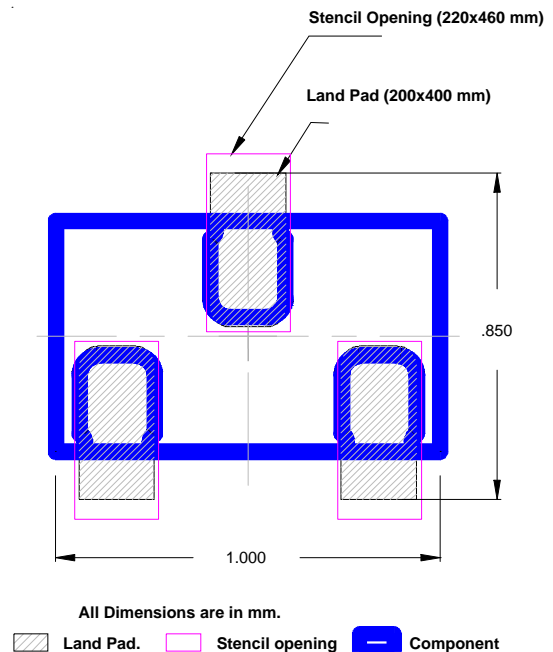

PROTECTION PRODUCTS

Outline Drawing - SLP1006N3T

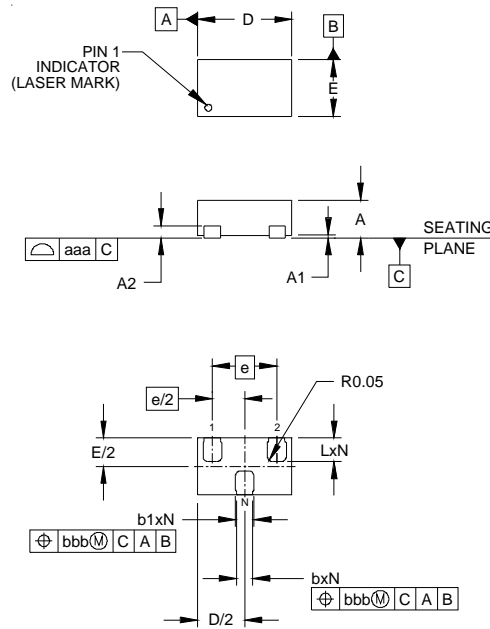

DIMENSIONS			
DIM	MILLIMETERS		
	MIN	NOM	MAX
A	0.37	0.40	0.43
A1	0.00	0.02	0.05
A2	(0.13)		
b	0.145	0.17	0.195
b1	0.175	0.20	0.225
D	0.90	1.00	1.10
E	0.50	0.60	0.70
e	0.68 BSC		
L	0.225	0.25	0.275
N	3		
aaa	0.08		
bbb	0.10		

- NOTES:
1. CONTROLLING DIMENSIONS ARE IN MILLIMETERS (ANGLES IN DEGREES).

Land Pattern - SLP1006N3T

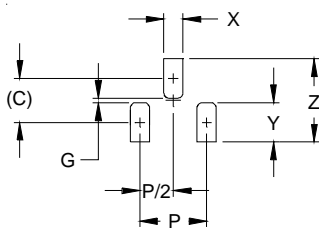

DIMENSIONS	
DIM	MILLIMETERS
C	(0.45)
G	0.05
P	0.68
X	0.20
Y	0.40
Z	0.85

- NOTES:
1. CONTROLLING DIMENSIONS ARE IN MILLIMETERS (ANGLES IN DEGREES).
 2. THIS LAND PATTERN IS FOR REFERENCE PURPOSES ONLY. CONSULT YOUR MANUFACTURING GROUP TO ENSURE YOUR COMPANY'S MANUFACTURING GUIDELINES ARE MET.

PROTECTION PRODUCTS

Marking Code

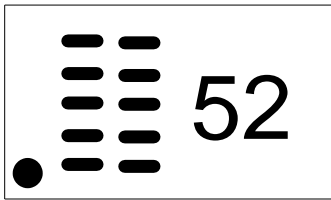

Notes:
Marking will also include line matrix date code

Ordering Information

Part Number	Qty per Reel	Reel Size
uClamp0552T.TNT	10,000	7 Inch

Notes:
MicroClamp, uClamp and μ Clamp are trademarks of Semtech Corporation

Carrier Tape Specification

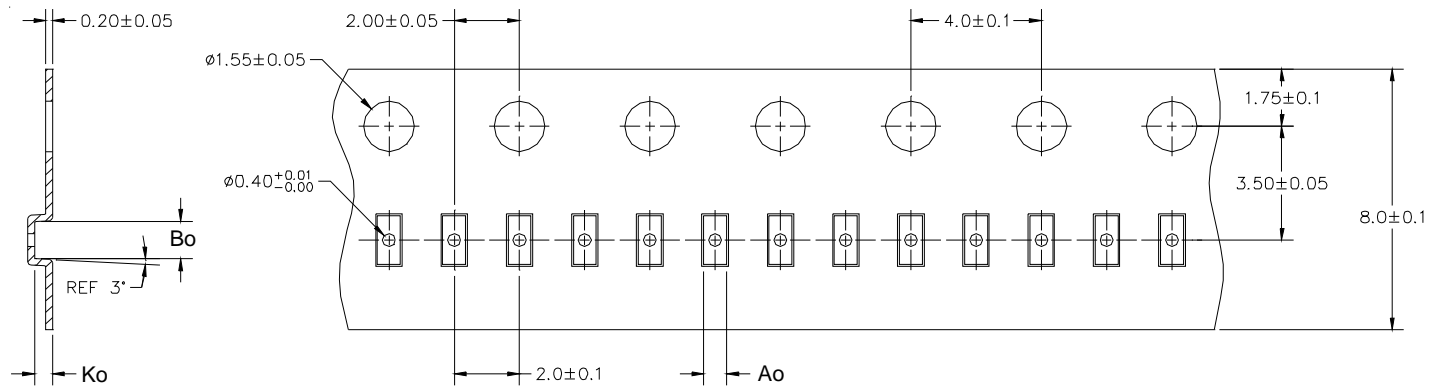

A0	B0	K0
0.70 +/-0.05 mm	1.15 +/-0.05 mm	0.55 +/-0.05 mm

Note: All dimensions in mm unless otherwise specified

Device Orientation in Tape

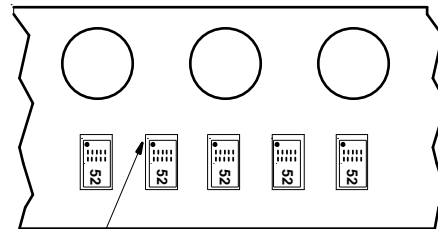

Pin 1 Location
(Towards Sprocket Holes)

Contact Information

Semtech Corporation
Protection Products Division
200 Flynn Rd., Camarillo, CA 93012
Phone: (805)498-2111 FAX (805)498-3804