

#### PROTECTION PRODUCTS - RailClamp®

#### Description

RailClamp® TVS arrays are low capacitance ESD protection devices designed to protect high speed data interfaces. The RClamp®2656P provides dedicated surge and ESD protection for uUSB ports. It is designed to replace multiple discrete components in portable applications. This device features low capacitance TVS diodes for protection of the USB data (DP, DM) and USB ID pins operating up to +/- 5 volts. These diodes provide ESD protection to  $\pm 15\text{kV}$  contact discharge per IEC 61000-4-2. Loading capacitance on these lines is  $<0.50\text{pF}$ . An integrated 26 volt TVS diode is used for protection of the USB voltage bus. The VBus TVS is designed with a high surge current capability of 80A (tp=8/20us) and low clamping voltage.

The RClamp2656P is in a 6-pin SLP2018P6 package. It measures 2.0 x 1.8mm with a nominal height of 0.57mm. This highly integrated device requires less board space than existing solutions.

The combination of small size, low capacitance, and high level of surge and ESD protection makes this device a flexible solution for protection of USB interfaces in mobile phones, laptops, and other portable electronics.

#### Features

- ◆ ESD and surge protection for USB Voltage Bus to **IEC 61000-4-2 (ESD)  $\pm 30\text{kV}$  (air),  $\pm 30\text{kV}$  (contact)**  
**IEC 61000-4-5 (Lightning) 80A (8/20 $\mu\text{s}$ )**  
**IEC 61000-4-4 (EFT) 40A (5/50ns)**
- ◆ ESD protection for USB data lines to **IEC 61000-4-2 (ESD)  $\pm 15\text{kV}$  (air),  $\pm 15\text{kV}$  (contact)**
- ◆ Protects USB DP, DM, and ID Pins operating up to +/- 5V
- ◆ Protects USB VBus operating up to 26V
- ◆ Low capacitance ( **$<0.50\text{pF}$** ) on DP, DM, and ID Pins
- ◆ Low clamping voltage
- ◆ Low dynamic resistance: 0.90 Ohms (Typ) on DP, DM, and ID Pins
- ◆ Solid-state silicon-avalanche technology

#### Mechanical Characteristics

- ◆ SLP2018P6 6L package
- ◆ Pb-Free, Halogen Free, RoHS/WEEE Compliant
- ◆ Nominal Dimensions: 2.0 x 1.8 x 0.57 mm
- ◆ Lead Finish: NiPdAu
- ◆ Molding compound flammability rating: UL 94V-0
- ◆ Marking : Marking Code + Date Code
- ◆ Packaging : Tape and Reel

#### Applications

- ◆ USB 2.0
- ◆ USB OTG
- ◆ uUSB

#### Circuit Diagram

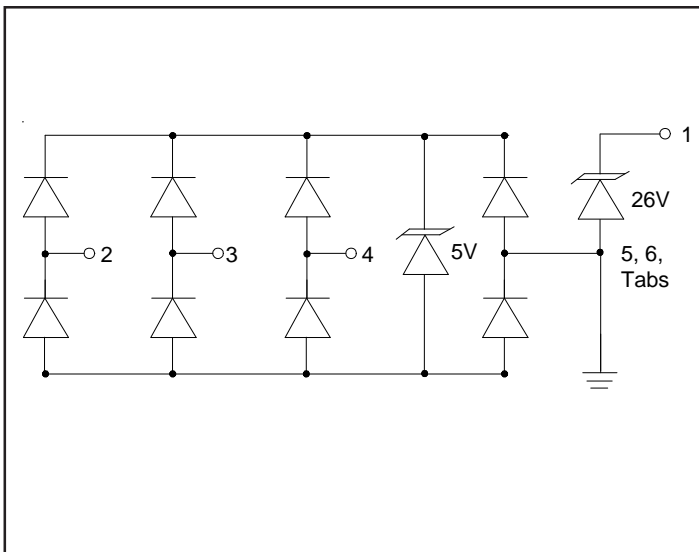

#### Pin Configuration

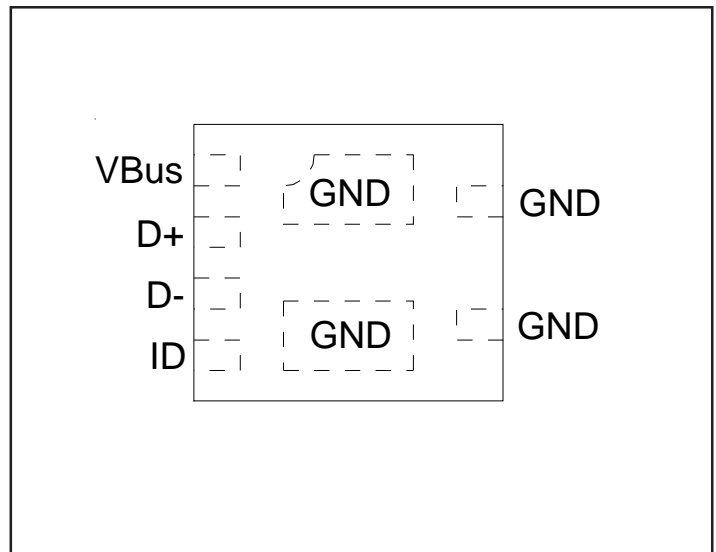

**PROTECTION PRODUCTS**
**Absolute Maximum Rating**

Rating	Symbol	Value	Units
<b>DP, DM, USB ID TVS</b>			
Peak Pulse Power (tp = 8/20μs)	$P_{pk}$	60	Watts
Peak Pulse Current (tp = 8/20μs)	$I_{pp}$	3	A
ESD per IEC 61000-4-2 (Air) ESD per IEC 61000-4-2 (Contact)	$V_{ESD}$	±15 ±15	kV
Operating Temperature	$T_j$	-55 to +125	°C
Storage Temperature	$T_{STG}$	-55 to +150	°C
<b>VBus TVS</b>			
Peak Pulse Power (tp = 8/20μs)	$P_{pk}$	3000	Watts
Peak Pulse Current (tp = 8/20μs)	$I_{pp}$	80	A
ESD per IEC 61000-4-2 (Air) ESD per IEC 61000-4-2 (Contact)	$V_{ESD}$	±30 ±30	kV
Operating Temperature	$T_j$	-55 to +125	°C
Storage Temperature	$T_{STG}$	-55 to +150	°C

**Electrical Characteristics (T=25°C)**

<b>VBus TVS (Pin 1)</b>						
Parameter	Symbol	Conditions	Minimum	Typical	Maximum	Units
Reverse Stand-Off Voltage	$V_{RWM}$	Pin 1 to GND			26	V
Reverse Breakdown Voltage	$V_{BR}$	$I_t = 1mA$ , Pin 1 to GND	28	30.5	31.9	V
Reverse Leakage Current	$I_R$	$V_{RWM} = 26V$ Pin 1 to GND		0.010	0.250	μA
Forward Voltage	$V_F$	$I_f = 10mA$ GND to Pin 1	0.6	0.7	1.0	V
Clamping Voltage	$V_C$	$I_{pp} = 10A$ , tp = 8/20μs Pin 1 to Ground			35	V
Clamping Voltage	$V_C$	$I_{pp} = 58A$ , tp = 8/20μs Pin 1 to Ground		39	43	V
Junction Capacitance	$C_j$	$V_R = 0V$ , f = 1MHz Pin 1 to GND		620	750	pF

**PROTECTION PRODUCTS**
**Electrical Characteristics (T=25°C)**

DM, DP, USB ID (Pins 2, 3, 4)						
Parameter	Symbol	Conditions	Minimum	Typical	Maximum	Units
Reverse Stand-Off Voltage	$V_{RWM}$	Pin 4, 5, or 6 to GND			5	V
Reverse Breakdown Voltage	$V_{BR}$	$I_t = 1mA$ , Pin 4, 5, or 6 to GND	6.5	9	11	V
Reverse Leakage Current	$I_R$	$V_{RWM} = 2.0V$ , Pin 4, 5, or 6 to GND		<0.005	0.020	$\mu A$
Reverse Leakage Current	$I_R$	$V_{RWM} = 5.0V$ , Pin 4, 5, or 6 to GND		0.005	0.100	$\mu A$
Clamping Voltage	$V_C$	$I_{pp} = 1A$ , $t_p = 8/20\mu s$ Pin 4, 5, or 6 to GND			15	V
Clamping Voltage	$V_C$	$I_{pp} = 3A$ , $t_p = 8/20\mu s$ Pin 4, 5, or 6 to GND			20	V
Dynamic Resistance <sup>1</sup>	$R_{Dyn}$	$I_{pp} = 4A$ to $I_{pp} = 16A$		0.90		Ohms
		$I_{pp} = -4A$ to $I_{pp} = -16A$		0.90		Ohms
Junction Capacitance	$C_j$	$V_R = 0V$ , $f = 1MHz$ , Pin 4, 5, or 6 to GND		0.28	0.50	pF

**Notes**

1)Transmission Line Pulse Test (TLP) Settings:  $t_p = 100ns$ ,  $t_r = 0.2ns$ ,  $I_{TLP}$  and  $V_{TLP}$  averaging window:  $t_1 = 70ns$  to  $t_2 = 90ns$

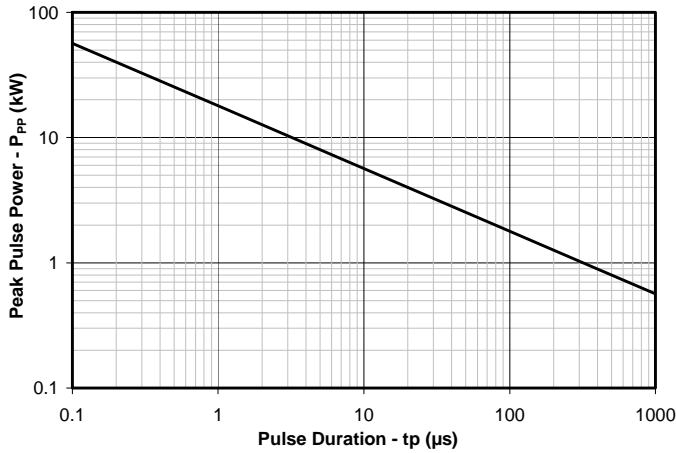
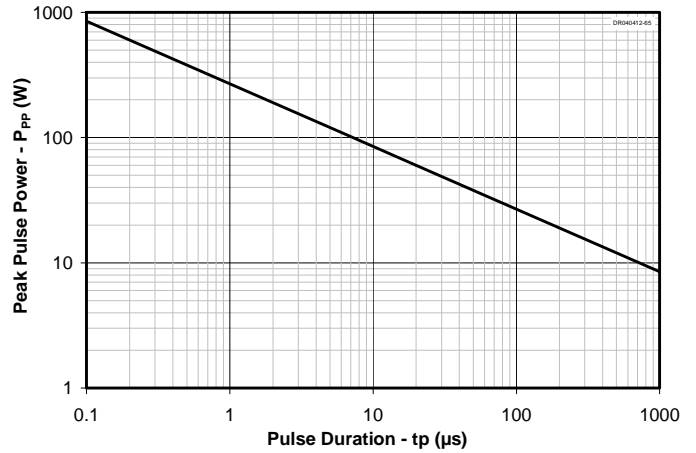
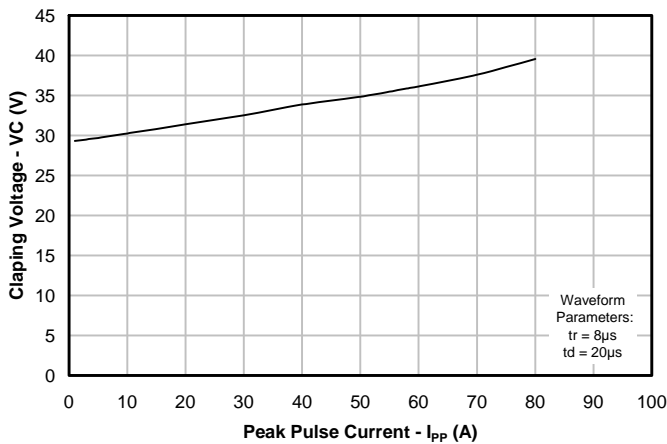
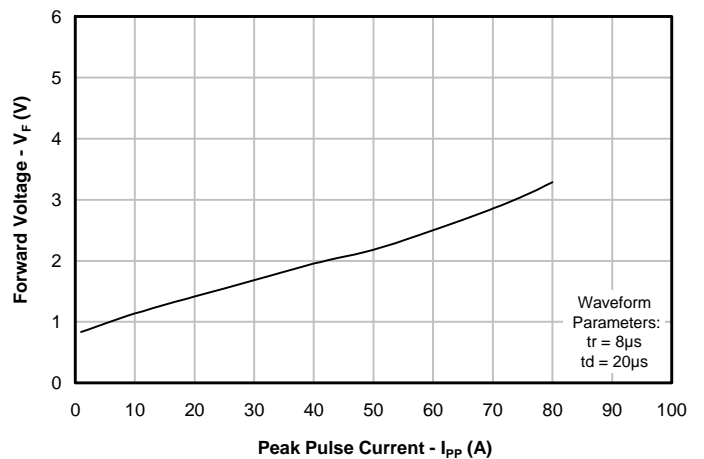
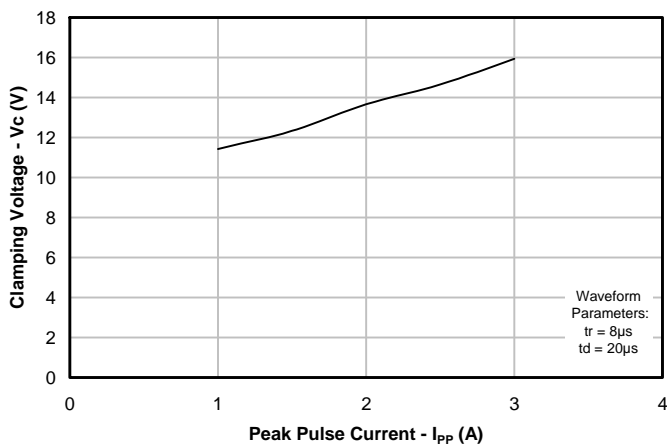
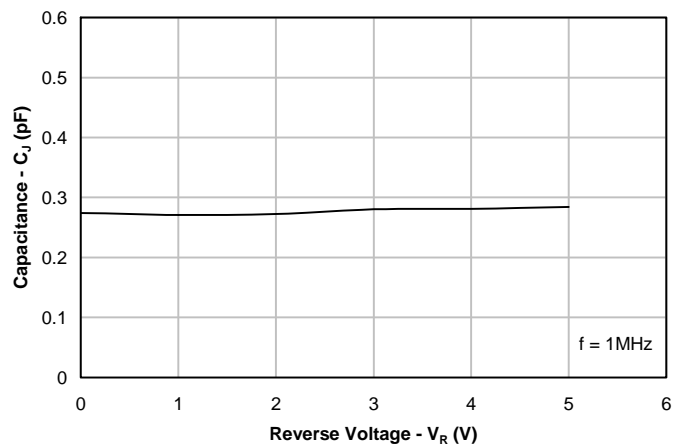
**PROTECTION PRODUCTS**
**Typical Characteristics**
**Non-Repetitive Peak Pulse Power vs. Pulse Time  
VBus Pin (Pin 1)**

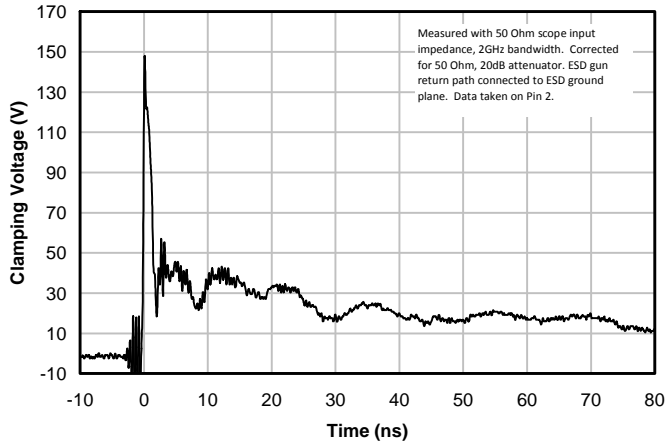
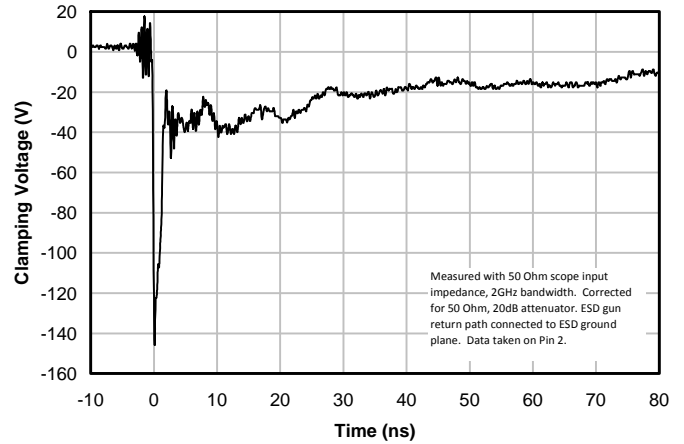
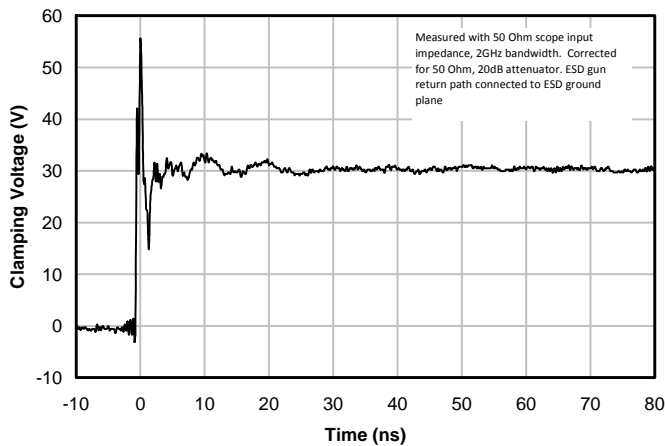
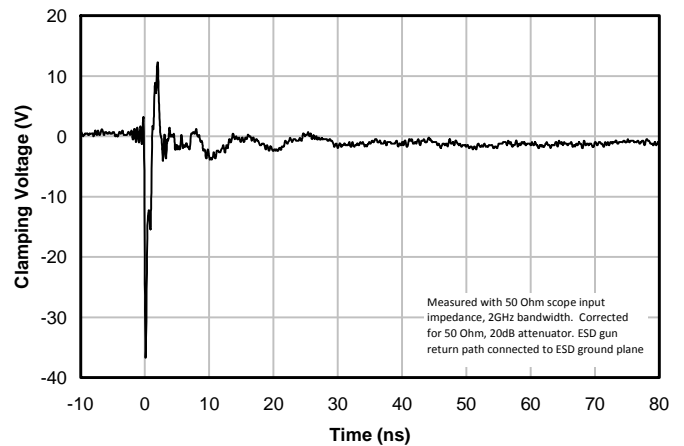
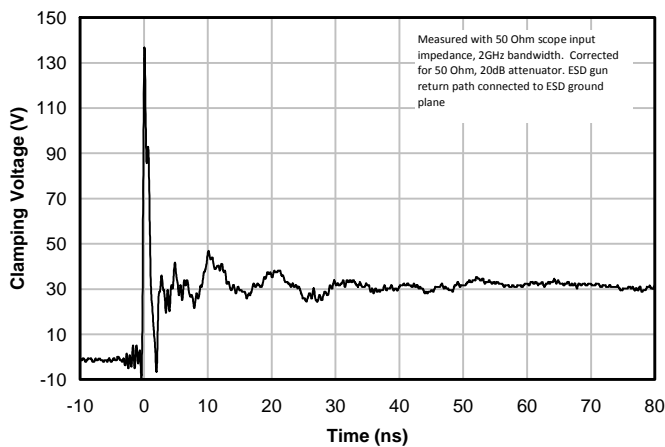
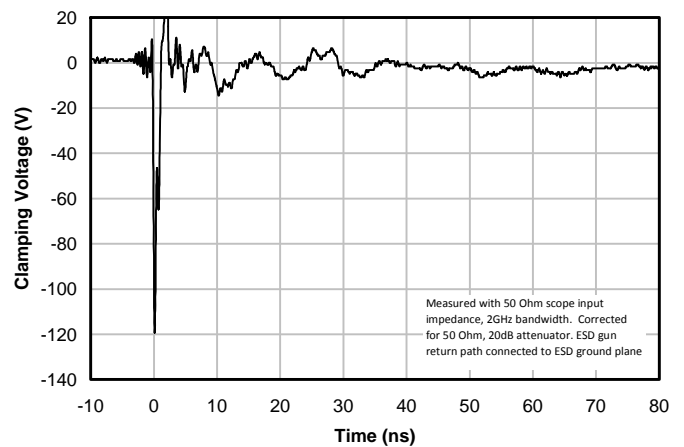
**Non-Repetitive Peak Pulse Power vs. Pulse Time  
D+, D-, ID Pins (Pins 2, 3, 4)**

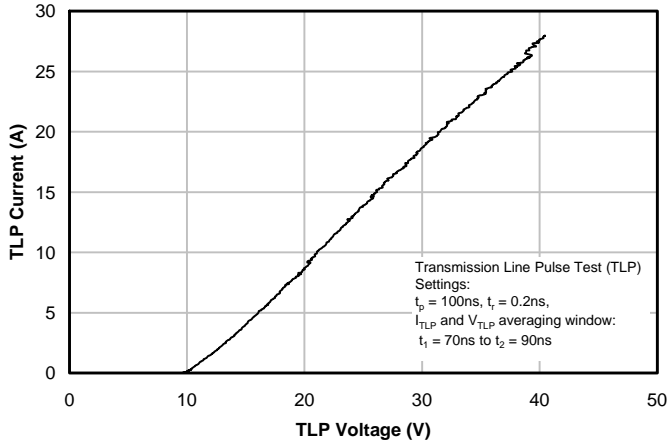
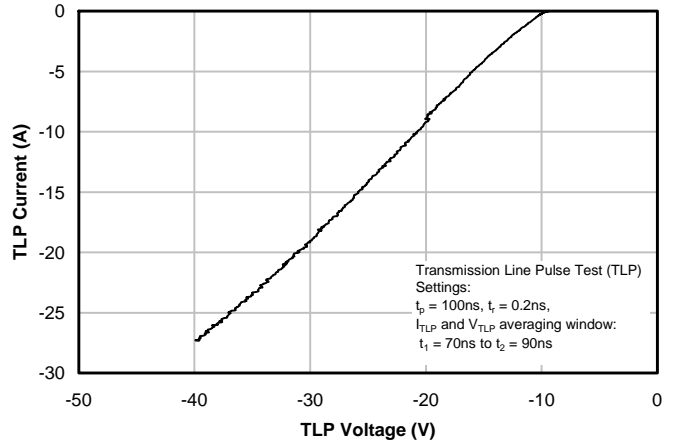
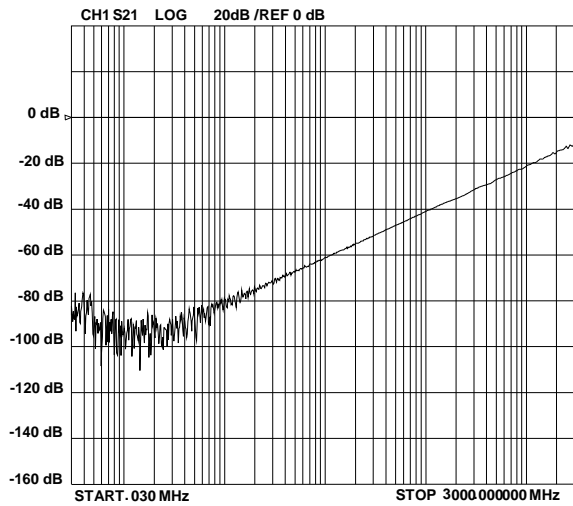
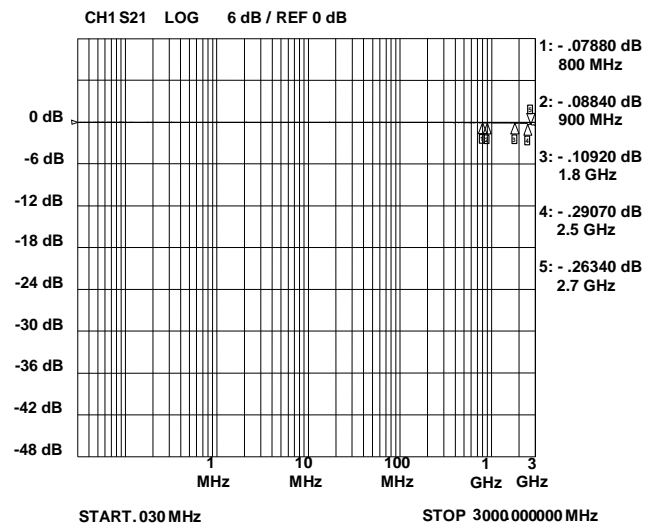
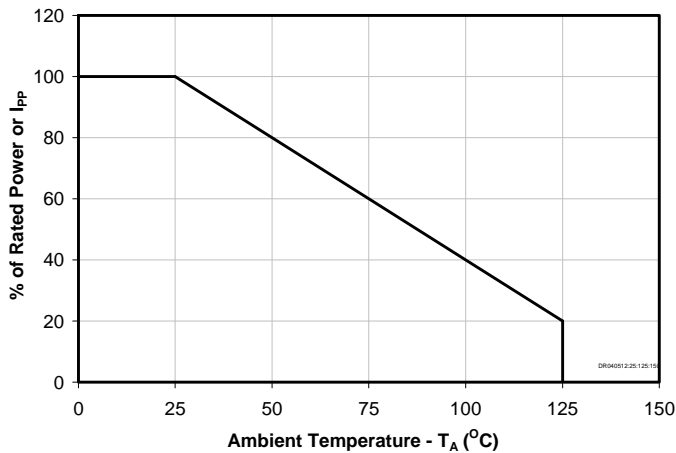
**Clamping Voltage vs. Peak Pulse Current  
VBus Pin (Pin 1)**

**Forward Voltage vs. Peak Pulse Current  
VBus Pin (Pin 1)**

**Clamping Voltage vs. Peak Pulse Current  
D+, D-, ID Pins (Pins 2, 3, 4)**

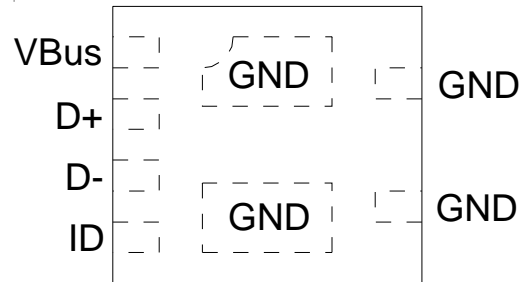
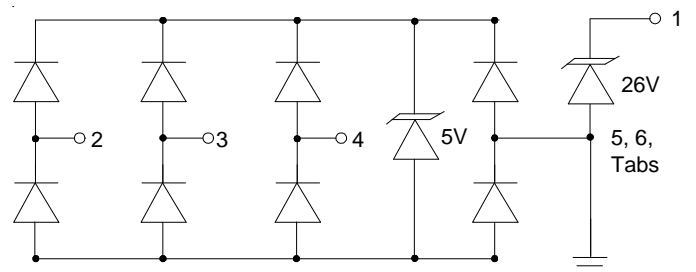
**Capacitance vs. Reverse Voltage  
D+, D-, ID Pins (Pins 2, 3, 4)**

**PROTECTION PRODUCTS**
**Typical Characteristics**
**ESD Clamping (+8kV Contact per IEC 61000-4-2)  
D+, D-. ID Pins (Pins 2, 3, 4)**

**ESD Clamping (-8kV Contact per IEC 61000-4-2)  
D+, D-. ID Pins (Pins 2, 3, 4)**

**ESD Clamping (+8kV Contact per IEC 61000-4-2)  
VBus Pin (Pins 1)**

**ESD Clamping (-8kV Contact per IEC 61000-4-2)  
VBus Pin (Pin 1)**

**ESD Clamping +30kV Contact per IEC 61000-4-2)  
VBus Pin (Pin 1)**

**ESD Clamping -30kV Contact per IEC 61000-4-2)  
VBus Pin (Pin 1)**

**PROTECTION PRODUCTS**
**Typical Characteristics**
**TLP Characteristic (Positive Pulse)**  
**D+, D-. ID Pins (Pins 2, 3, 4)**

**TLP Characteristic (Negative Pulse)**  
**D+, D-. ID Pins (Pins 2, 3, 4)**

**Analog Crosstalk**  
**D+, D-. ID Pins (Pins 2, 3, 4)**

**Typical Insertion Loss S21**  
**D+, D-. ID Pins (Pins 2, 3, 4)**

**Non-Repetitive Peak Pulse Power Derating Curve**

**PROTECTION PRODUCTS**
**Applications Information**
**Device Connection and Layout Options for Protecting One USB Port**

The RClamp2656P is optimized for protection of USB ports. Low capacitance protection is provided for the USB data (DM, DP) and USB ID pins. The maximum capacitance on these lines is <math><0.5\text{pF}</math> for maximum signal integrity. USB Data and ID lines are connected at pins 2, 3, and 4. These inputs are referenced to an internal 5 volt TVS protection device. When the voltage on these lines exceed 5 volts, the TVS will conduct. Pin 1 is connected to the USB voltage bus (VBus). This device will conduct when the voltage on the bus exceeds 26 volts. Ground is provided at pins 5, 6, and the center tabs. Multiple micro vias connected to ground are recommended for best ESD performance. This will reduce parasitic inductance in the ground path and minimize the clamping voltage seen by the protected device.

**Figure 1 - Pin Configuration (Top View)**

**Figure 2 - Schematic**

**PROTECTION PRODUCTS**
**Applications Information**

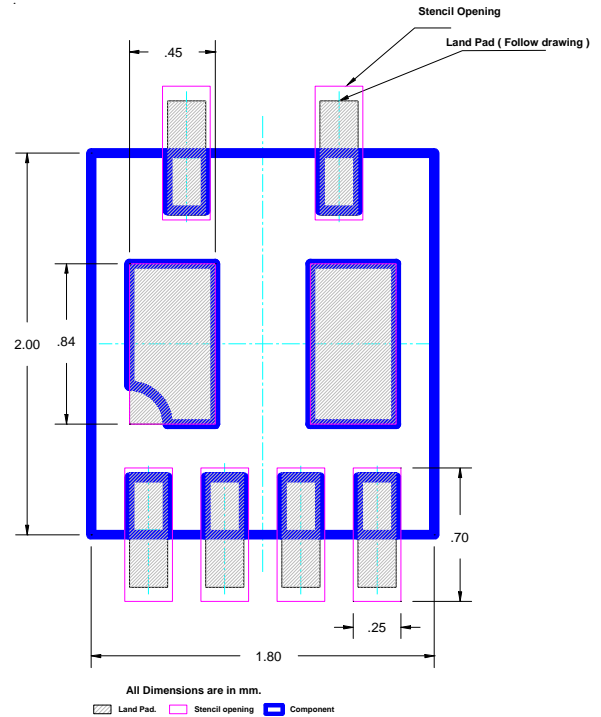
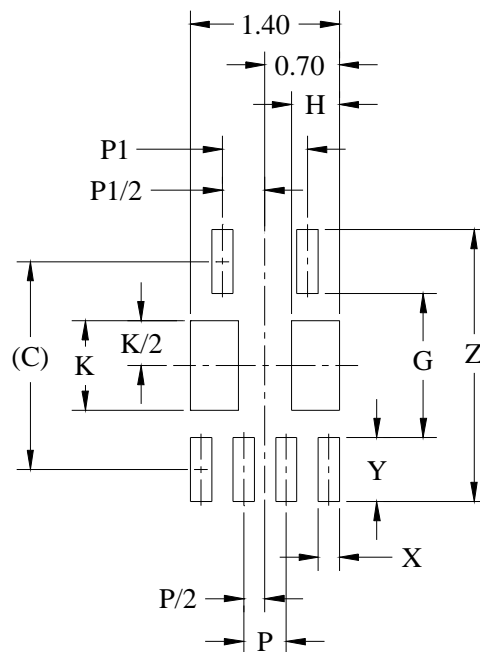
Assembly Parameter	Recommendation
Solder Stencil Design	Laser cut, Electro-polished
Aperture shape	Rectangular
Solder Stencil Thickness	0.100 mm (0.004")
Solder Paste Type	Type 3 size sphere or smaller
Solder Reflow Profile	Per JEDEC J-STD-020
PCB Solder Pad Design	Non-Solder mask defined
PCB Pad Finish	OSP OR NiAu



**Recommended Mounting Pattern**
**Land Pattern - SLP2018P6**

DIMENSIONS	
DIM	MILLIMETERS
C	(1.95)
G	1.35
H	0.45
K	0.84
P	0.40
P1	0.80
X	0.20
Y	0.60
Z	2.55

**NOTES:**

1. CONTROLLING DIMENSIONS ARE IN MILLIMETERS (ANGLES IN DEGREES).
2. THIS LAND PATTERN IS FOR REFERENCE PURPOSES ONLY.  
CONSULT YOUR MANUFACTURING GROUP TO ENSURE YOUR COMPANY'S MANUFACTURING GUIDELINES ARE MET.

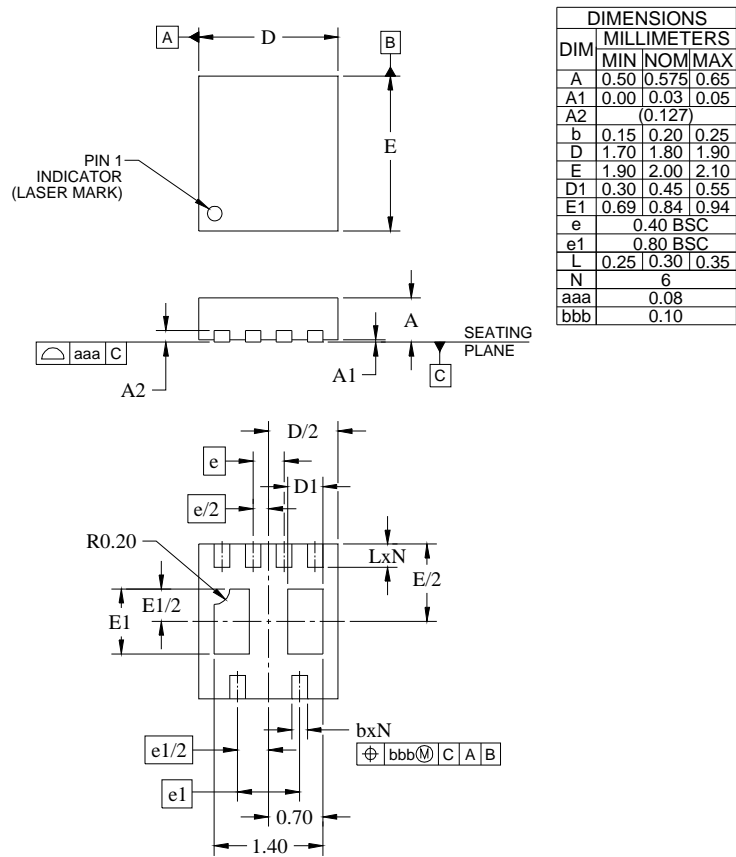

**PROTECTION PRODUCTS**
**Outline Drawing - SLP2018P6**

NOTES:  
1. CONTROLLING DIMENSIONS ARE IN MILLIMETERS (ANGLES IN DEGREES).

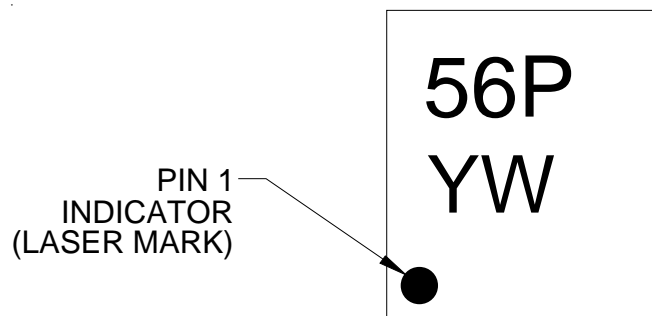
**Marking**

YW = Date Code

## PROTECTION PRODUCTS

### Ordering Information

Part Number	Qty per Reel	Reel Size
RClamp2656P.TGT	10,000	13 Inch

RailClamp and RClamp are trademarks of Semtech Corporation.

### Carrier Tape Specification

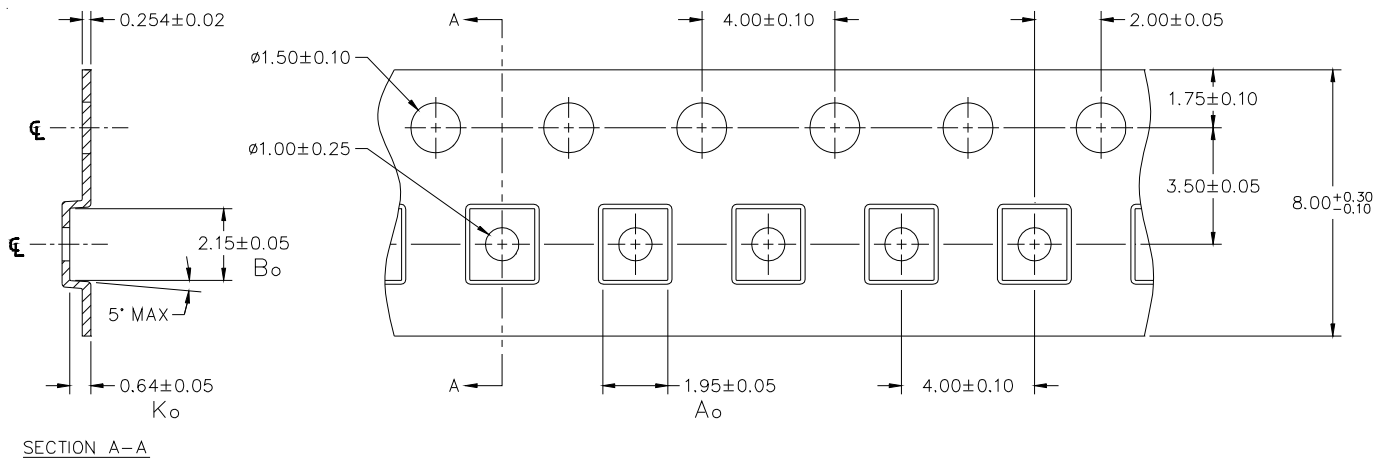

NOTE: ALL DIMENSIONS IN MILLIMETERS UNLESS OTHERWISE SPECIFIED.

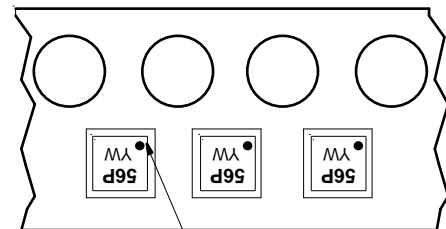

**Device Orientation in Tape**

### Contact Information

Semtech Corporation  
 Protection Products Division  
 200 Flynn Road, Camarillo, CA 93012  
 Phone: (805)498-2111 FAX (805)498-3804